

4X79 ANALOG SYSTEM

Users guide for system with digital loadcells and analog output



Applies for:

Software: Std.170607.1v4

Document no.: 0607mu4x79-1v4

Date: 2022-08-01

Rev.: 1v4

1) Contents

1) Contents	2
2) Users guide	4
2.1 Introduction	4
2.2 Connection of power supply	4
2.3 ATEX (Ex) specification	4
2.4 Power-up sequence	5
2.5 Operator panel.....	5
2.5.1 Lamp functionality	5
2.5.2 Key functionality.....	6
2.6 General display and keyboard behavior.....	6
2.7 Parameter list	7
2.8 Data entry and requests.....	7
2.8.1 Changing/adjusting parameters.....	7
2.8.2 Performing requests.....	8
2.8.3 Data locking and unlocking	8
3) Parameter descriptions.....	9
3.1 LoAd parameter	9
3.2 OutPut parameter	9
3.3 PASS parameter.....	9
3.4 ZErO parameter	10
3.5 CAL.L. parameter	10
3.6 CAL. parameter.....	11
3.6.1 Performing a system calibration.....	11
3.7 CAL.F. parameter	11
3.8 n.Lc. parameter	12
3.9 n.Crn. parameter	12
3.10 Int.PEr. parameter.....	13
3.11 Unit parameter.....	13
3.12 dPno parameter	14
3.13 div parameter	14
3.14 SP. 1 and SP. 2 parameters	14
3.15 An.SP. parameter	15
3.16 An.Err. parameter	15
3.17 An.tESt parameter.....	15
3.18 An.tyPE parameter	16
3.19 Lc. X parameter	16
3.20 nnAc X parameter.....	17
3.21 IP X parameter.....	17
3.22 Sub.n. X parameter	17
3.23 Port.no. parameter	18
3.24 Eth.nEt. parameter	18
3.25 Level alarms	19
3.26 Filtering	20
4) Ethernet communication.....	21
4.1 Ethernet - Specification.....	21
4.2 Ethernet – Data exchange	21
5) Hardware Description.....	22
5.1 4x79 overview	22
5.2 4x79 front panel description	22
5.2.1 Connection of power	23
5.2.2 Connection of loadcells	23
5.2.3 Analog output connector.....	23
5.2.4 Digital I/O connector.....	24

5.2.5 Ethernet connector	24
5.2.6 SW1 settings.....	24
5.2.7 SW2 settings.....	25
5.2.8 Light Emitting Diodes (LEDs).....	25
6) Appendices	26
6.1 Appendix A: Connection of power	26
6.1.1 Non-ATEX applications	26
6.1.2 ATEX applications	27
6.2 Appendix B: Internal Features	28
6.2.1 4079 analog module	28
6.2.2 Connectors	28
6.2.3 Jumper settings.....	28
6.2.4 Light Emitting Diodes (LEDs).....	29
6.2.5 4040 communication module	29
6.2.6 SW2 settings.....	29
6.2.7 Jumper settings.....	30
6.2.8 Light Emitting Diodes (LEDs).....	30
6.3 Appendix C: 4x79 Installation checklist.....	31
6.4 Appendix D: 4x79 Parameter list.....	32
6.5 Appendix E: Trouble shooting	33
6.5.1 Trouble shooting – Status code indication.....	33
6.5.2 Trouble shooting – Analog output error	33
6.6 Appendix F: Actual filter characteristics.....	34
6.7 Appendix G: Status Codes.....	35

2) Users guide

2.1 Introduction

This document describes the 4x79 analog module from Eilersen Electric, when equipped with the software version stated on the front page. The 4x79 system unit consists internally of a 4079 analog module (with the software listed on the front page) and a 4040 communication module.

The 4x79 system unit is connected to X loadcells (1-4).

With the software version specified on the front page, the 4x79 analog module is capable of transmitting the weight for a system with up to 4 loadcells as an analog 4-20 mA signal (or 0-10V depending on factory settings) as well as on the Ethernet connection.

The 4x79 analog module is operated using a 6 digit display and 5 keys for viewing/configuring a series of system parameters.

By use of DIP switches it is possible to include one of 15 different FIR filters, that will be used to filter the weight signal.

2.2 Connection of power supply

IMPORTANT: Connection of power supply (24VDC) MUST be made to BOTH the green two pole power connectors (J6 and J3) as specified on the front panel of the 4x79 unit.

IMPORTANT: In regards to ATEX installations each of the green two pole power connectors (J6 and J3) MUST be connected to EACH of their own SEPARATE power supply as described later; see "6.1 Appendix A: Connection of power".

2.3 ATEX (Ex) specification

IMPORTANT: Instrumentation (the 4x79A) must be placed outside the hazardous zone if the load cells are used in hazardous ATEX (Ex) area. Furthermore, only ATEX certified load cells and instrumentation can be used in ATEX applications.

2.4 Power-up sequence

When power is applied to the 4x79 system, the following steps will be performed:

- The **D1** lamp (LED) will turn ON and back OFF shortly after.
- For 2 seconds all segments in the display will be lit like this:



This allows for inspection that display and all lamps are working.

- For 2 seconds the display will then show:



- For 3 seconds the display will show its program date like this:



- For 3 seconds the display will show its program revision like this:



During this period the 4x79 system will start communicating with the loadcells and the **TXBB** lamp will turn ON.

- The 4x79 system is ready and enters the normal operation mode showing the **LoAd** parameter.

2.5 Operator panel

The operator panel holds a 6 character LED display, a number of lamps, keys and DIP switches. The display will normally show the actual load indication or other parameters used to operate/configure the 4x79 system. Below the display the five keys are located.





2.5.1 Lamp functionality

The different lamps located in the front of the 4x79 system work as follows:

- TXBB (left)** Turns ON (green) when 4079 is communicating with 4040 (internally).
- D1** Turns ON (yellow) when a key is activated or entry is in progress.
- AE** Turns ON (red) if an error is detected on the analog output.
- TXLC** Turns ON (yellow) when 4040 is communicating with loadcells.
- TXBB (right)** Turns ON (green) when 4040 is communicating with 4079 (internally).
- 1 - 4** Turns ON (red) when an error is detected on loadcell X (1 - 4).

2.5.2 Key functionality



The general function of the keys in the front panel is as follows:

- | | |
|---|--|
|  | Step to next parameter in parameter list. |
|  | Starts data entry of the selected parameter and increments value. |
|  | Starts data entry of the selected parameter and decrements value. |
|  | Aborts data entry without change, or steps to previous parameter. |
|  | Accepts adjusted value and terminates data entry. This key must be pressed in order to accept any change of a parameter. |



Further description of the keys is made below in the chapter "Data entry".

2.6 General display and keyboard behavior

When a parameter is shown the display will alternately show "**XXXXXX**" and "**YYYYYY**". Here "**XXXXXX**" will be a text indicating the actual parameter name, and "**YYYYYY**" will indicate the actual value or request belonging to this parameter.

The next parameter in the parameter list (see below) can be shown by pressing the  key, and the previous key can be shown by pressing the  key.

By continuous holding down a key, a keyboard repeat feature will be activated after a while, which gradually increases the speed by which the key is automatically considered reactivated.

By holding down the  key and then pressing the  key the **LoAd** parameter is selected.

2.7 Parameter list

The 4x79 system has the following parameters, which can be viewed and possibly changed using the user interface:

PARAMETER	DESCRIPTION
LoAd	Display current load on loadcells.
OutPut	Display current analog output signal (0.00-20.00mA).
PASS	Display/Change password for unlocking/locking data entry.
ZERo	Request zero of current load indication.
CAL.L.	Display/Change calibration load used.
CAL.	Perform system calibration.
CAL.F.	Display/Change system calibration factor (default is 524288).
n.Lc.	Display/Change number of loadcells connected.
n.Crn.	Display/Change number of supporting corners.
Int.PEr.	Display/Change integration period (measurement time in ms).
Unit	Display/Change weighing range unit (Kg, Lb., Gram, Tons).
dPno	Display/Change weighing range dpno (digits after decimal point).
div	Display/Change weighing range division.
SP. 1	Display/Change setpoint for controlling digital output OUT1.
SP. 2	Display/Change setpoint for controlling digital output OUT2.
An.SP.	Display/Change load value for full analog output signal.
An.Err.	Display/Change analog output value used during error (0.00-20.00).
An.tEST	Enter analog test mode and output different test values (0.00-20.00).
An.tyPE	Display/Change signal type transferred on analog output.
Lc. 0 - Lc. 3	Display individual loadcell signals/status for connected loadcells.
nnAc 0 - nnAc 5	Display MAC address part for the module used during Ethernet communication.
IP 0 - IP 3	Display/Change IP address part for the module used during Ethernet communication.
Sub.n. 0 - Sub.n. 3	Display/Change Subnet mask part for the module used during Ethernet communication.
Port.no.	Display/Change port number for the module used during Ethernet communication.
Eth.nEt.	Display/Change signal type transferred on Ethernet communication.

During normal operation the **LoAd** parameter should be selected for display of actual load on the loadcells. A complete description of the different parameters and their usage is given below.

2.8 Data entry and requests

In order to make changes to the different parameters or to perform requests from the keyboard (perform a zero etc.), the parameters have to be unlocked by setting the correct password as described later. Changing parameters (including the password) and performing requests from a parameter is done as follows.

2.8.1 Changing/adjusting parameters

Once a parameter is selected, then its value can be changed/adjusted by using the keys as follows:

↑ or ↓ Use the up and down keys until the desired value is reached.

- ↵ Once the desired value is reached, the ↵ key **MUST** be pressed in order to accept the new parameter value.
- Esc or F Aborts data entry without any changes to the parameter value.

Please note that some parameters can only be set to certain predetermined values. When parameter entry is in progress the yellow **D1** lamp will be ON to indicate this. The D1 lamp will turn OFF once the data entry is completed by pressing the ↵ key or aborted by pressing the Esc key or the F key.

Example - Changing calibration load from 0.000 to 1.250:

After having ensured the correct password is set use the F key (possibly the Esc key instead) to step forward (or backwards) to the **CAL.L.** parameter.

- Then use the ↑ key and the ↓ key until the display shows **1.250**.
- The yellow **D1** lamp will be ON during the above process.
- Press the ↵ key to accept the new value and complete the data entry.
- The yellow **D1** lamp will turn OFF once the data entry is completed.

2.8.2 Performing requests

Some parameters are used to perform requests (such as zeroing) instead of changing/adjusting a parameter. Once such a parameter is selected, then the corresponding request can be performed by using the keys as follows:

- ↵ Press the ↵ key to perform the selected request.

Example – Performing a zero when display shows 0.120:

After having ensured the correct password is set use the F key (possibly the Esc key instead) to step forward (or backwards) to the **ZERo** parameter where the load indication shows **0.120**.

- Then press the ↵ key to perform the zero.
- Inspect that the request has been performed and that the load indication shows **0.000**.

2.8.3 Data locking and unlocking

When the power is turned on all parameters are locked. The parameters can be unlocked by setting the correct password in the **PASS** parameter. As long as the password differs from the correct password, **ALL** parameter change and user requests from the keyboard are locked. The password for unlocking and allowing parameter change is:

1357

Note: If the display is left showing the **LoAd** parameter without any keyboard activity for 5 minutes or more, the password will automatically reset to 0.

3) Parameter descriptions

The following is a description of each available parameter for this application.

3.1 LoAd parameter

When the **LoAd** parameter is selected the LED display toggle between showing the parameter name and the current load indication on the loadcells, as follows:

The image shows two states of a 7-segment LED display. On the left, the characters 'LoAd' are displayed in red, with the first two characters 'Lo' being smaller than the last two 'Ad'. On the right, the number '00000' is displayed in red. The background shows the other segments of the display in a light grey color.

The load indication is shown in the unit specified by the weighing range parameters.

If the load is above the weighing range the display will show "- OL -".

If the load is below the weighing range the display will show "- UL -".

If an error is present a status code will be shown ("-XXXX-") instead of the load indication. In this situation the analog output signal will be determined by the **An.Err.** parameter instead of the actual load on the loadcells. A complete list of status codes is shown in **6.7 Appendix G: Status Codes**.

The **F** and **Esc** keys can be used to switch to other parameters.

3.2 OutPut parameter

When the **OutPut** parameter is selected the LED display toggle between showing the parameter name and the current analog output value controlled by the load indication, as follows:

The image shows two states of a 7-segment LED display. On the left, the characters 'OutPut' are displayed in red, with the first two characters 'Ou' being smaller than the last four 'tPut'. On the right, the number '000400' is displayed in red. The background shows the other segments of the display in a light grey color.

The analog output value shown in the **OutPut** parameter is in mA (or V depending on factory settings/configuration).

The **F** and **Esc** keys can be used to switch to other parameters.

3.3 PASS parameter

When the **PASS** parameter is selected the LED display toggle between showing the parameter name and the current password, as follows:

The image shows two states of a 7-segment LED display. On the left, the characters 'PASS' are displayed in red. On the right, the number '0000123' is displayed in red. The background shows the other segments of the display in a light grey color.

The correct password for unlocking data entry and requests is **1357**. For all other password values entered, data entry and requests are NOT possible.

The ,  and  keys can be used to change/adjust the password.

If the display is left showing the **LoAd** parameter without any keyboard activity for 5 minutes or more, the password will automatically reset to 0.

IMPORTANT: Always remember to clear the password when done changing parameters.

3.4 ZErO parameter

When the **ZErO** parameter is selected the LED display toggle between showing the parameter name and the current load indication on the loadcells, as follows:



The display shows the same load indication as in the **LoAd** parameter.

The  key can be used to perform a zero request of the load indication on the loadcells. The zero should only be done with an empty and clean weighing platform.

A zeroed and empty system will cause the analog output signal to go to its minimum value (4mA or 0V). Note that on a 4x79 analog module running in current configuration, the analog output signal can go below 4mA for negative load indications.

NOTE: A zero request is performed (as described earlier) by pressing the  key.



NOTE: A zero request can also be performed by activating the digital ZERO input implemented on the digital I/O connector. Zeroing using the digital input can be performed regardless of password value and the selected display parameter.

3.5 CAL.L. parameter

When the **CAL.L.** parameter is selected the LED display toggle between showing the parameter name and the calibration load used during calibration, as follows:



If calibration is necessary the used calibration load must set using the **CAL.L.** parameter before the calibration is performed. The calibration load is shown in the same unit and resolution as the **LoAd** parameter. The calibration itself is performed in the **CAL.** parameter.

The ,  and  keys can be used to change/adjust the calibration load.

3.6 CAL. parameter

When the **CAL.** parameter is selected the LED display toggle between showing the parameter name and the current load indication on the loadcells, as follows:



The display shows the same load indication as in the **LoAd** parameter.

The  key can if necessary be used to perform a needed system calibration request of the load indication on the loadcells.

NOTE: A system calibration request is performed (as described earlier) by pressing the  key.

The complete system calibration procedure for calibration is described below.

3.6.1 Performing a system calibration

If necessary, it is possible to perform a system calibration from the **CAL.** parameter by performing the following system calibration procedure:



- Allow calibration by entering correct password in the **PASS** parameter.
- Ensure the weighing scale is empty and clean.
- Use the **ZErO** parameter to zero the load indication if necessary.
- Use the **CAL.L.** parameter to enter the used calibration load. Please notice that the accuracy of the calibration is deeply dependent on the accuracy and size of the calibration load. Please select a load with a mass not less than the maximum load normally applied to the system.
- Place the calibration load on the weighing arrangement.
- Select the **CAL.** parameter, and to request the system calibration the  key is now pressed.
- The load indication shown in the **CAL.** parameter and several other parameters will now match the used calibration load and the system calibration factor has been updated correspondingly.
- Use the **CAL.F.** parameter and note the achieved calibration factor, so that the calibration can be re-established later.
- The system is now calibrated and the calibration should be protected by clearing the password (set to 0).
- Select **LoAd** parameter verify that a given load results in a matching weight indication.

3.7 CAL.F. parameter

When the **CAL.F.** parameter is selected the LED display toggle between showing the parameter name and the system calibration factor used for system calibration of the load indication, as follows:



If manual inspection/change of the system calibration is necessary the system calibration factor can be viewed/changed using the **CAL.F.** parameter. The system calibration factor is changed whenever a new system calibration is performed using the **CAL.** parameter and should be noted so that it is possible to re-establish the system calibration.

The ,  and  keys can be used to change/adjust the system calibration factor.

The calibration factor lays in the interval 104858 to 943718 with 524288 as the standard calibration factor (corresponding to no calibration). If the calibration factor is changed 1% (up or down), the load indication will also change 1% (up or down). By changing the calibration factor within the stated interval it is possible to change the load indication with $\pm 80\%$. The procedure for calibration is described above.

NOTE: The following relationship between calibrated indication, uncalibrated indication and the calibration factor applies:



$$\text{Weight}_{\text{CAL.}} = [(\text{CAL.F.}) / 524288] * \text{Weight}_{\text{UNCAL.}}$$

3.8 n.Lc. parameter

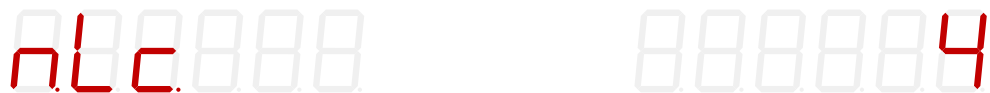
When the **n.Lc.** parameter is selected the LED display toggle between showing the parameter name and the number of loadcells for which the 4x79 system is configured to, as follows:



During installation the actual number of loadcells (1-4) connected to the 4x79 system must be configured using the **n.Lc.** parameter. The 4x79 system can be connected to a maximum of 4 loadcells. As an example, the **n.Lc.** parameter should be 1 in a system consisting of a three legged tank, where only one corner contains a loadcell.

The ,  and  keys can be used to change/adjust the number of loadcells.



NOTE: If a change is made to this parameter, the power MUST be turned OFF and ON for the change to take effect.

3.9 n.Crn. parameter

When the **n.Crn.** parameter is selected the LED display toggle between showing the parameter name and the number of supporting corners (points) in the weighing arrangement, as follows:



During installation the actual number of supporting points (1-8) in the weighing arrangement must be configured using the **n.Crn.** parameter. Note that it is the total number of supporting points including corners supported by loadcells. As an example, the **n.Crn.** parameter should be 3 in a system consisting of a three legged tank.



The ,  and  keys can be used to change/adjust the number of supporting points.

3.10 Int.PEr. parameter

When the **Int.PEr.** parameter is selected the LED display toggle between showing the parameter name and the integration period, as follows:

The image shows two states of a 7-segment LED display. On the left, the text 'Int.PEr.' is displayed in red, with the 'n' and 'r' characters being slightly dimmer than the 'I', 't', 'P', and 'E'. On the right, the number '0000100' is displayed in red, with the '1' and '00' at the end being slightly dimmer than the other digits.

The integration period (measurement time) is the interval between each update of the load indication and must be specified in the **Int.PEr.** parameter during installation.

The ,  and  keys can be used to change/adjust the integration period.

The integration period is entered in milliseconds (ms). A small value results in fast update of the display reading, while a larger value results in a more steady display reading.

NOTE: All loadcells are sampled/averaged over the time period selected in the **Int.PEr.** parameter (typical 20ms, 40ms, 100ms, 200ms, 400ms, 1000ms, 2000ms or 4000ms). The hereby found loadcell signals are used to generate the weight reading and the 4-20 mA (or 0-10V) analog output signal until new signals are achieved when the next sample/average period expires.

NOTE: If Ethernet communication is used, it should be ensured when using small measurement periods, that the connected equipment is able to receive all the transmitted data.



NOTE: A good initial starting value is 200 ms.

3.11 Unit parameter

When the **Unit** parameter is selected the LED display toggle between showing the parameter name and the weighing range unit with which load indications are shown, as follows:

The image shows two states of a 7-segment LED display. On the left, the text 'Unit' is displayed in red, with the 'n' and 't' characters being slightly dimmer than the 'U' and 'i'. On the right, the number '0000kg' is displayed in red, with the 'kg' at the end being slightly dimmer than the other digits.

During installation the desired weighing range unit (Kg, Lb., gram or tons) must be configured using the **Unit** parameter.

The ,  and  keys can be used to change/adjust the weighing range unit.



NOTE: The unit is set depending on the actual loadcells used.

3.12 dPno parameter

When the **dPno** parameter is selected the LED display toggle between showing the parameter name and the weighing range decimal point position with which load indications are shown, as follows:



During installation the desired weighing range decimal point position must be configured using the **dPno** parameter. The decimal point position is specified as the number of digits following the decimal point.

The ,  and  keys can be used to change/adjust the weighing range decimal point position.



NOTE: The decimal point position is set depending on the actual loadcells used.

3.13 div parameter

When the **div** parameter is selected the LED display toggle between showing the parameter name and the weighing range division (resolution) with which load indications are shown, as follows:



During installation the desired weighing range division/resolution must be configured using the **div** parameter. The division/resolution can be selected from a range of predefined values.

The ,  and  keys can be used to change/adjust the weighing range division.

NOTE: The division/resolution is set depending on the actual loadcells used.

3.14 SP. 1 and SP. 2 parameters

When the **SP. 1** or **SP. 2** parameter is selected the LED display toggle between showing the parameter name and the appropriate setpoint used for controlling the two level alarms implemented on the digital outputs (OUT1 and OUT2) described later, as follows:



or

The image shows two digital displays. The left display shows 'SP.1' in red, followed by '2000' in red, and three greyed-out digits. The right display shows four greyed-out digits followed by '400000' in red.

The setpoints used to control the level alarms on the digital outputs must be set using the **SP. 1** or **SP. 2** parameter during installation if these outputs are to be used. The setpoints for the digital outputs are shown in the same unit and resolution as the **LoAd** parameter.



The ,  and  keys can be used to change/adjust the setpoints.

3.15 An.SP. parameter

When the **An.SP.** parameter is selected the LED display toggle between showing the parameter name and the analog setpoint used for scaling the analog output signal, as follows:

The image shows two digital displays. The left display shows 'An.SP.' in red, followed by two greyed-out digits. The right display shows four greyed-out digits followed by '400000' in red.

The analog setpoint used to indicate the load resulting in full scale output signal must be set using the **An.SP.** parameter during installation. The analog setpoint is shown in the same unit and resolution as the **LoAd** parameter.

The ,  and  keys can be used to change/adjust the analog setpoint.



NOTE: A good initial value for the analog setpoint could be the total capacity of all the loadcells connected to the 4x79 system.

3.16 An.Err. parameter

When the **An.Err.** parameter is selected the LED display toggle between showing the parameter name and the analog error value used during error situations, as follows:

The image shows two digital displays. The left display shows 'An.Err.' in red, followed by three greyed-out digits. The right display shows two greyed-out digits followed by '20000' in red.

The analog error value (0-20mA or 0-10V) used to control the analog output during error situations must be set using the **An.Err.** parameter during installation.

The ,  and  keys can be used to change/adjust the analog error value.



NOTE: A good initial value for the analog error value is 20.00mA.

3.17 An.tEst parameter



When the **An.tEst** parameter is selected the LED display toggle between showing the parameter name and the status of the analog test parameter, as follows:



The image shows two digital displays. The left display shows 'An.tEst' in red, followed by two greyed-out digits. The right display shows three greyed-out digits followed by 'OFF' in red.

The analog test parameter can be used to enable an analog test mode for testing the analog output signal. If test mode is enabled the value controlling the analog output normally determined by the load on the loadcells can be overwritten by a manually selected value.

The ,  and  keys can be used to enable the analog test mode and change the value controlling the analog output.

Once the **An.tESt** parameter is selected the display will show "OFF" indicating that the analog test mode is disabled. To enable the analog test mode the  key must be pressed. When the analog test mode is enabled, the display will instead show an analog test value that is sent out on the analog output. **NOTE** that this value overrides the normal analog output signal (based on the actual load indication) for as long as the analog test mode is enabled.

When the analog test mode is enabled, it is possible to change the analog test value by using the  or  key. Thus it is possible to set 21 different predetermined values from 0.00 to 20.00 mA (or 0.00 to 10.00V).

The analog test mode is disabled by pressing the  key when still in **An.tESt** parameter. The analog test mode is also automatically disabled once the **An.tESt** parameter is left by pressing the  key. Once the analog test mode is disabled, the analog output signal will again be controlled by the actual load indication.



3.18 An.tyPE parameter

When the **An.tyPE** parameter is selected the LED display toggle between showing the parameter name and the actual signal type used to control the analog output signal, as follows:



The analog type (**LoAd** or **Lc. 0 – Lc. 3**) which determines what signal type is used to control the analog output signal must be set using the **An.tyPE** parameter during installation.

LoAd can be selected causing the analog output signal to follow the load indication shown in **LoAd** parameter. Alternately **Lc. 0** through **Lc. 3** can be selected causing the analog output signal to follow one of the loadcell signals shown in **Lc. x** parameter.

The ,  and  keys can be used to change/adjust the analog type.

NOTE: During normal circumstances the parameter should be set to **LoAd**.

3.19 Lc. X parameter

When the **Lc. X** parameter is selected the LED display toggle between showing the parameter name and the loadcell signal for the selected loadcell (0-X), as follows:



The loadcell signal (for the selected loadcell) is zeroed and shown in the same unit and resolution as the **LoAd** parameter.

If an error is detected (such as disconnection of the loadcell) an appropriate status code will be shown ("**-XXXX-**") instead of the load indication.

The **[F]** and **[Esc]** keys can be used to switch to other parameters.

3.20 nnAc X parameter

When the **nnAc X** parameters are selected the LED display toggle between showing the parameter name and the selected part (0-5) of the MAC address (used in Ethernet communication) of the 4x79 module, as follows:



The six MAC address parameters constitute the entire MAC address as follows:

MAC0 : MAC1 : MAC2 : MAC3 : MAC4 : MAC5

3.21 IP X parameter

When the **IP X** parameters are selected the LED display toggle between showing the parameter name and the selected part (0-3) of the IP address (used in Ethernet communication) of the 4x79 module, as follows:



The IP address of the 4x79 module must be set using the **IP X** parameters during installation if Ethernet communication is used. The four IP address parameters constitute the entire IP address as follows:

IP0 . IP1 . IP2 . IP3

The **[↑]**, **[↓]** and **[←]** keys can be used to change/adjust the IP address.

NOTE: The default factory setting for the IP address is: 192.168.1.199



3.22 Sub.n. X parameter

When the **Sub.n. X** parameters are selected the LED display toggle between showing the parameter name and the selected part (0-3) of the subnet mask (used in Ethernet communication) of the 4x79 module, as follows:

The image shows a red LED display with two parts. The left part shows the text 'SUBN00' in a seven-segment font, where the first three characters are in red and the last two are in grey. The right part shows the number '255' in red, with three grey zeros to its left.

The subnet mask of the 4x79 module must be set using the **Sub.n. X** parameters during installation if Ethernet communication is used. The four subnet mask parameters constitute the entire subnet mask as follows:

SUBN0 . SUBN1 . SUBN2 . SUBN3

The ,  and  keys can be used to change/adjust the subnet mask.



NOTE: The default factory setting for the subnet mask is: 255.255.255.0

3.23 Port.no. parameter

When the **Port.no.** parameter is selected the LED display toggle between showing the parameter name and the port number (used in Ethernet communication) of the 4x79 module, as follows:

The image shows a red LED display with two parts. The left part shows the text 'Port.no.' in a seven-segment font, where the first three characters are in red and the last two are in grey. The right part shows the number '2984' in red, with two grey zeros to its left.

The port number of the 4x79 module must be set using the **Port.no.** parameter during installation if Ethernet communication is used.

The ,  and  keys can be used to change/adjust the port number.

NOTE: The default factory setting for the port number is: 2984



3.24 Eth.nEt. parameter

When the **Eth.nEt.** parameter is selected the LED display toggle between showing the parameter name and the actual signal type transmitted on the Ethernet communication channel, as follows:

The image shows a red LED display with two parts. The left part shows the text 'ETHnEt.' in a seven-segment font, where the first three characters are in red and the last two are in grey. The right part shows the text 'LoAd' in red, with two grey zeros to its left.

The Ethernet type (**LoAd** or **Lc. 0** – **Lc. 3**) which determines what signal type is transmitted on the Ethernet communication channel must be set using the **Eth.nEt.** parameter during installation if Ethernet communication is used.

LoAd can be selected causing the load indication shown in **LoAd** parameter to be transferred. Alternately **Lc. 0** through **Lc. 3** can be selected causing one of the loadcell signals shown in **Lc. x** parameter to be transferred.

The ,  and  keys can be used to change/adjust the Ethernet type.

NOTE: During normal circumstances the parameter should be set to **LoAd**.

3.25 Level alarms

The 2 digital outputs on the 4x79 analog module can be used as level alarms. Setpoints for the two alarms are set using the **SP. 1** or **SP. 2** parameters. The following applies to the two level alarms:

Level alarm 1:

- The alarm is implemented on the **OUT1** output.
- The level of activation is selected in the **SP. 1** parameter.
- The alarm is active **BELOW** SP1.
- The alarm is active if the status code differs from 0.

Level alarm 2:

- The alarm is implemented on the **OUT2** output.
- The level of activation is selected in the **SP. 2** parameter.
- The alarm is active **ABOVE** SP2.
- The alarm is active if the status code differs from 0.

3.26 Filtering

By use of DIP-switches it is possible to include one of 15 different FIR filters, that will be used to filter the load signal. Thus it is possible, to send the unfiltered weight achieved over each integration period through one of the following FIR filters, before the result is displayed and send to the analog output:

SW2.4	SW2.3	SW2.2	SW2.1	Filter No.
OFF	OFF	OFF	OFF	0
ON	OFF	OFF	OFF	1
OFF	ON	OFF	OFF	2
ON	ON	OFF	OFF	3
OFF	OFF	ON	OFF	4
ON	OFF	ON	OFF	5
OFF	ON	ON	OFF	6
ON	ON	ON	OFF	7
OFF	OFF	OFF	ON	8
ON	OFF	OFF	ON	9
OFF	ON	OFF	ON	10
ON	ON	OFF	ON	11
OFF	OFF	ON	ON	12
ON	OFF	ON	ON	13
OFF	ON	ON	ON	14
ON	ON	ON	ON	15

NOTE: With all switches OFF, no filtering is performed.

The actual filter characteristics of the selected filter is shown below in **6.6 Appendix F: Actual filter characteristics**.

NOTE: The DIP-switches are only read during power-on.

4) Ethernet communication

This chapter describes the Ethernet communication on the RJ45/Cat5 Ethernet connector of the 4x79 analog system.

4.1 Ethernet - Specification

Protocol:	TCP/IP to PC. The 4x79 module is TCP server
Communication settings	10MB/s, Half duplex
IP-Address:	Fixed (default: 192.168.1.199)
TCP Port:	Selectable
Ethernet connection:	RJ45/Cat5

4.2 Ethernet – Data exchange

The 4x79 analog module transmits status and measured weight every measurement period on the TCP connection (Ethernet) based on what has been selected in the **Eth.nEt.** parameter. The result is transmitted as an ASCII string, and is only send if a client is connected to the TCP server on the 4x79 module. Only 1 TCP connection can be opened.

If **LoAd** is selected the contents of the transmitted telegram is:

`<Status> , <Load> <LF> <CR>`

If **Lc. 0** through **Lc. 3** is selected the contents of the transmitted telegram is:

`<LcStatus [x]> , <LcSignal [x]> <LF> <CR>`

where:

- <LF> is a line feed character.
- <CR> is a carriage return character.
- <Status> is the status code as shown in the **LoAd** parameter. This is a 4 character long hex number and should be 0000 during normal error free operation.
- <Load> is the gross weight as shown in the **LoAd** parameter. This is a 6 character long value. Note that this field will be 7 characters long if a decimal point is used.
- <LcStatus[x]> is the status code as shown in the **Lc. x** parameter. This is a 4 character long hex number and should be 0000 during normal error free operation.
- <LcSignal[x]> is the loadcell signal as shown in the **Lc. x** parameter. This is a 6 character long value. Note that this field will be 7 characters long if a decimal point is used.

NOTE: If Ethernet communication is used, it should be ensured when using small measurement periods, that the connected equipment is able to receive all the transmitted data. Selecting small measurement periods (possibly combined with a long filter) may slow down operation considerably or even stop Ethernet or load cell communication. A combination of a larger measurement period and a shorter filter is a better choice and will prevent these problems.

5) Hardware Description

5.1 4x79 overview

The following figure is an overview of a 4x79 analog system unit with 4 loadcell connections (i.e. a 4479 system unit):



5.2 4x79 front panel description

This chapter describes the connections, DIP-switch settings and lamp indications that are available on the front panel of the 4x79 system unit.

5.2.1 Connection of power

The 4x79 system unit is powered by applying +24VDC on **BOTH** the green two pole connectors (**J6** and **J3**) as specified on the front panel of the 4x79 system unit. This powers the entire 4x79 system unit including the loadcells.

IMPORTANT: The used power supply must be stable and free of transients. It may therefore be necessary to use a separate power supply dedicated to the weighing system, and not connected to any other equipment.

NOTE: If the loadcells are to be placed inside an EX area, then the 4x79 system unit itself **MUST** be placed outside the EX area, and the 4x79 system unit **MUST** be supplied as follows:

- 1) The 2 pole connector (**J3**), located to the right above the 4 pole DIP-switch block, **MUST** be powered by a 4051A power supply (+24VDC ATEX approved) from Eilersen Electric.
- 2) The 2 pole connector (**J6**), located to the left "between" the display and the BNC connectors, **MUST** be powered by a separate +24VDC, that has **NO** connection to the ATEX approved +24VDC from the above mentioned 4051A power supply.

NOTE: In **6.1 Appendix A: Connection of power** figures are showing how power supply is connected to Non-ATEX and ATEX applications respectively.

5.2.2 Connection of loadcells

The loadcells must be connected to the available BNC connectors in the front panel of the 4x79 system unit. The loadcells are connected starting with the connector marked 1 and continuing onwards in rising order. Thus if three loadcells are to be connected, they should be connected to the BNC connectors marked 1, 2 and 3.

5.2.3 Analog output connector

The 2 pole connector (J1) located below the display on the 4x79 analog unit is used for connection of the analog output signal. Connection of the analog output signal is done as follows:

PIN NO.	PIN DESIGNATION	FUNCTION
1	AN. OUT	Analog output
2	AN. RET	Analog return

NOTE:

The analog output is an active output, and should NOT be connected to an active input.

5.2.4 Digital I/O connector

The 7 pole connector located below the display on the 4x79 analog unit is used for connection of the digital inputs and digital outputs. Connection of the digital inputs and digital outputs is done as follows:

PIN NO.	PIN DESIGNATION	FUNCTION
1	OUT1 (O1)	OUT1 - Digital Output 1 Level alarm controlled by SP1. Output is active below SP1.
2	COM	Common Voltage connected to this pin (normally 24VDC) is sent to outputs when they are active.
3	OUT2 (O2)	OUT2 - Digital Output 2 Level alarm controlled by SP2. Output is active above SP2.
4	IN1 (I1)	Digital Input 1 (IN1) – ZERO Zeroing of gross weight. Must be active for at least 1 second. Closing switch to 24VDC_{out} .
5	GND	GND
6	IN2 (I2)	Digital Input 2 (IN2) <i>Reserved for future use – NOT connected</i>
7	24V OUT	24VDC_{out} Used for activating digital inputs.

IMPORTANT: Connection of the digital I/O signals to external equipment must be made using solid-state-relays (SSR).

5.2.5 Ethernet connector

The front panel of the 4x79 system unit is equipped with a standard Ethernet RJ45 connector (**ETHERNET**) for Ethernet connection using a Cat5 cable.

5.2.6 SW1 settings

The front panel of the 4x79 system unit is equipped with a 4 pole DIP switch block named **SW1**. These switches are mounted on the internal 4040 communication module, and they are **ONLY** read during power-on. This DIP switch block has the following function when the 4040 communication module is equipped with standard program:

Sw1.1	FIR Filter
OFF	No filter
ON	30 taps

SWITCH	FUNCTION
Sw1.2-Sw1.4	<i>Reserved for future use</i>

5.2.7 SW2 settings

The front panel of the 4x79 system unit is equipped with a 4 pole DIP switch block named **SW2**. These switches are **ONLY** read during power-on. This DIP switch block has the following function:

SWITCH	FUNCTION
Sw2.1-Sw2.4	Filtering Used to select the desired filter as described in an earlier chapter.

5.2.8 Light Emitting Diodes (LEDs)

The front panel of the 4x79 system unit is equipped with a number of status lamps (light emitting diodes). These have the following functionality:

LED	FUNCTION
TXBB (left) (Green)	4079 communication with 4040 module (internal) 4079 analog module is transmitting to 4040 module.
D1 (Yellow)	Key is pressed A key is activated or data entry is in progress.
AE (Red)	Analog Error An error has been detected on the analog output. The current on the analog output differs from its programmed value. This may be the case if the current-loop is broken.
TxLC (Yellow)	4040 communication with loadcells 4040 comm. module is communicating with loadcells.
TxBB (right) (Green)	4040 comm. with 4079 analog module (internal) 4040 comm. module is transmitting to 4079 analog module.
1 (Red)	Status for loadcell 1 Bad connection, loadcell not ready or other error detected.
2 (Red)	Status for loadcell 2 Bad connection, loadcell not ready or other error detected.
3 (Red)	Status for loadcell 3 Bad connection, loadcell not ready or other error detected.
4 (Red)	Status for loadcell 4 Bad connection, loadcell not ready or other error detected.
ETHERNET (Yellow) (RJ45)	Link (Ethernet connector) Ethernet is connected.
ETHERNET (Green) (RJ45)	Activity (Ethernet connector) Ethernet data is received or transmitted.

6) Appendices

6.1 Appendix A: Connection of power

6.1.1 Non-ATEX applications

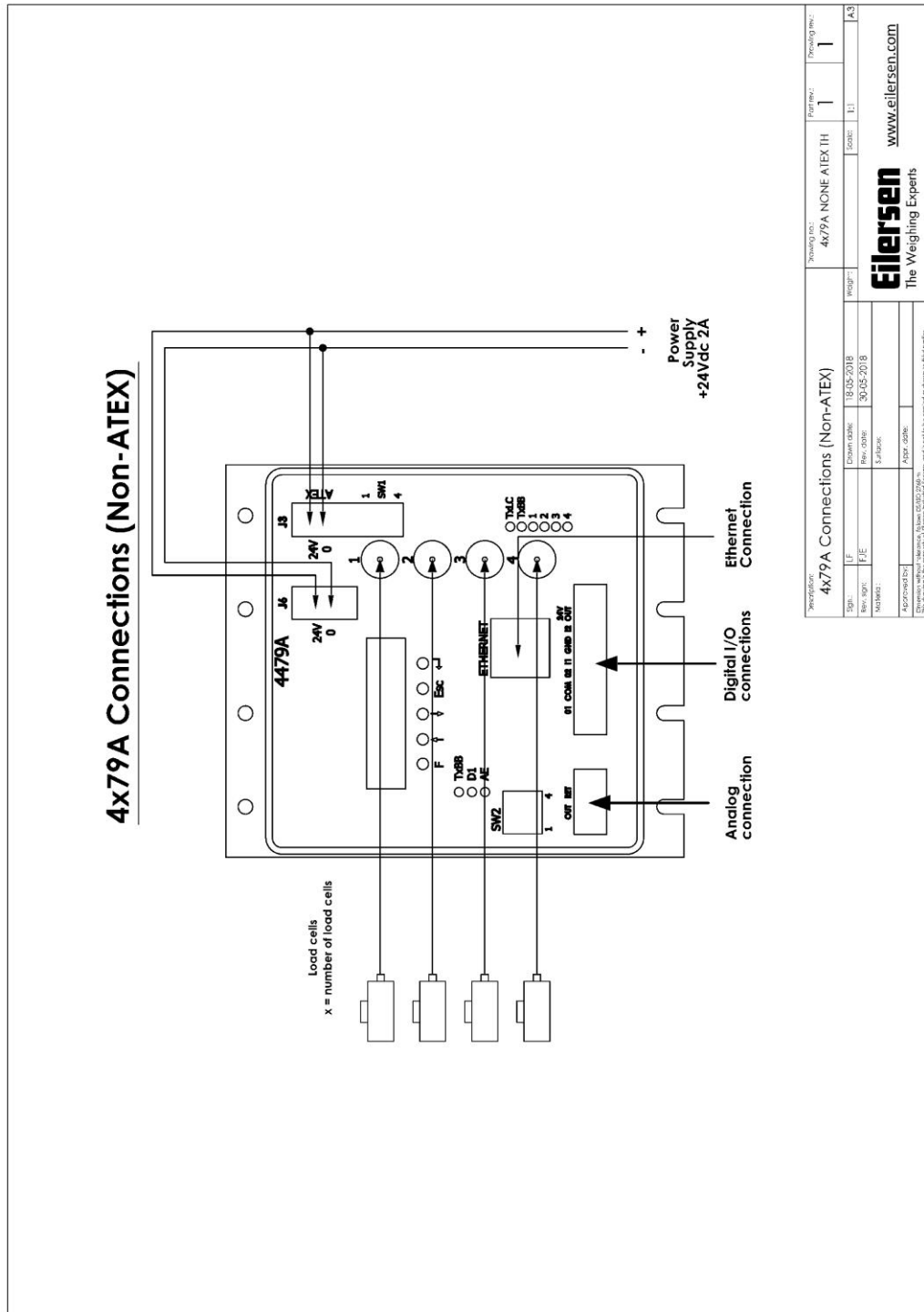

6.1.2 ATEX applications

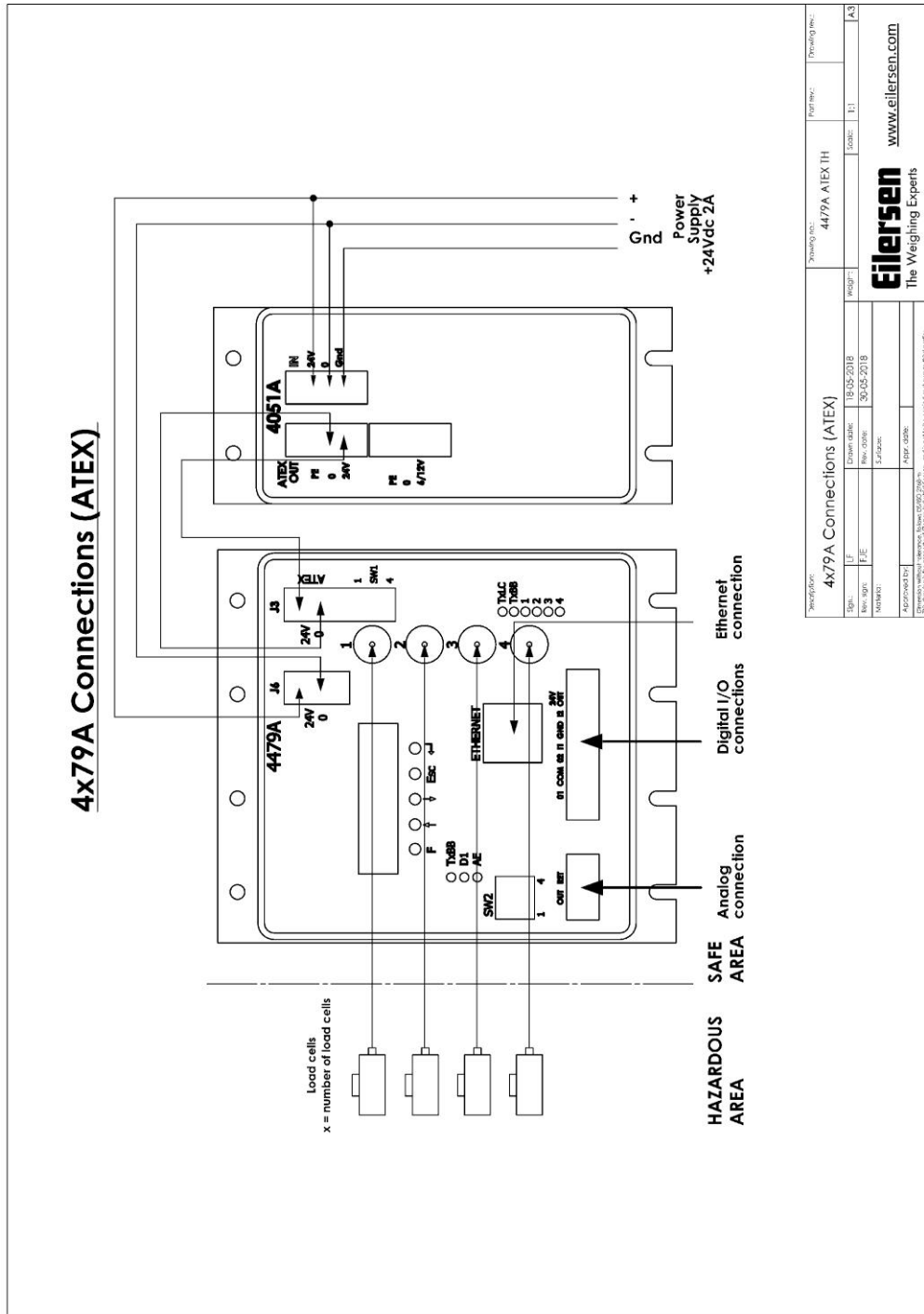

Description:		Drawing no.:		Drawing rev.:	
4x79A Connections (ATEX)		4479A ATEX IH		1.1	
Scale:	15/05/2018	Model:	30/05/2018	Scale:	A3
Rev. no.:	1	Rev. date:	30/05/2018	Scale:	1:1
Manufacturer:	Eilersen	Model:	30/05/2018	Scale:	1:1
Approved by:		Model:	30/05/2018	Scale:	1:1
<p>Eilersen The Weighing Experts</p> <p>www.eilersen.com</p>					

6.2 Appendix B: Internal Features

6.2.1 4079 analog module

This chapter describes possible connections, jumper settings and LEDs that are available internally on the 4079 analog module. Jumpers will normally be set from Eilersen Electric and should only be changed in special situations.

6.2.2 Connectors

The 4079 analog module is internally equipped with connectors (and pin rows). These connectors have the following function:

CONNECTORS	FUNCTION
J2	14 pin connector <i>Reserved for future direct connection of 4015 module.</i>
J7	14 pin connector for 4040 connection Used for connection to 4040 module for loadcell connection.
J5	JTAG connector (pin row) Used for test purposes.
J8	UART1 connector (pin row) This connector is used for test purposes or when downloading new software to the 4079 module using the JP12 jumper.

6.2.3 Jumper settings

The 4079 analog module is equipped with a number of internal jumpers. These jumpers have the following function:

JUMPER	FUNCTION
J4	Analog output type (mA or Volt) Jumper on pin 1-2 : mA output (normal setting from factory) Jumper on pin 2-3 : Voltage output
JP1	Configuration jumper <i>Reserved for future use</i>
JP2	Analog output type (mA or Volt) OFF: mA output (normal setting from factory) ON: Voltage output
JP11	Reset The jumper allows reset of the onboard microcontroller. OFF: Normal operation (normal setting from factory) ON: Reset of the 4079 on-board microcontroller
JP12	BOOT Load The jumper is used when downloading new software to the 4079 module using the J8 serial connector. OFF: Normal power-up/operation (normal setting from factory) ON: Download operation possible (see download description)

IMPORTANT: The placement of these should not be changed without consulting Eilersen Electric A/S.

6.2.4 Light Emitting Diodes (LEDs)

The 4079 analog module is equipped with a number of internal LEDs. These LEDs have the following functionality:

LED	FUNCTION
D17 (Green)	RS485 TX Data is transmitted on RS485 (to 4040 internally).
D18 (Yellow)	RS485 RX Data is received on RS485) (from 4040 internally).

6.2.5 4040 communication module

For information on jumper settings, DIP-switch settings, LED status lamps etc. on the 4040 communication module that is not covered in the above or below, please refer to the separate documentation that describes the 4040 communication module and its specific software.

6.2.6 SW2 settings

The 4040 communication module is internally equipped with an 8 pole DIP switch block named SW2. Please note that these switches are **ONLY** read during power-on. This DIP switch block has the following function when the 4040 communication module is equipped with standard program:

Sw2.1	Sw2.2	Sw2.3	Number of loadcells
OFF	OFF	OFF	1
ON	OFF	OFF	1
OFF	ON	OFF	2
ON	ON	OFF	3
OFF	OFF	ON	4
ON	OFF	ON	5
OFF	ON	ON	6
ON	ON	ON	6

SWITCH	FUNCTION
Sw2.4-Sw2.8	<i>Reserved for future use</i>

6.2.7 Jumper settings

The 4040 communication module is internally equipped with 4 jumpers named P2, P3, P4 and P5. In this system, these jumpers must be set as follows:

JUMPER	POSITION
P2	OFF (Loadcell connected to 4040 NOT accessible using SEL1)
P3	OFF (Loadcell connected to 4040 NOT accessible using SEL6)
P4	OFF (Loadcell connected to 4040 NOT accessible using SEL1)
P5	OFF (Loadcell connected to 4040 NOT accessible using SEL6)

6.2.8 Light Emitting Diodes (LEDs)

The 4040 communication module is internally equipped with a number of status lamps (light emitting diodes). The lamps have the following functionality when the 4040 communication module is equipped with standard program:

LED	FUNCTION
<i>D11</i> (Red)	<i>Reserved for future use</i>
<i>D12</i> (Red)	<i>Reserved for future use</i>
<i>D13</i> (Red)	<i>Reserved for future use</i>
<i>D14</i> (Red)	<i>Reserved for future use</i>

6.3 Appendix C: 4x79 Installation checklist

During installation of the system the following should be checked/performed:

ACTION	PARAMETERS
1. Check loadcells	Check loadcells are mounted mechanically correct.
2. Check electrical connections	Check power supply, loadcells, digital I/O, analog interface and Ethernet connection.
3. Check DIP switch settings	Check DIP switches on 4x79 analog module selects desired filtering.
4. Apply power and check software ID	Check software indication during power up sequence matches program name on front page.
5. Unlock parameters	Enter the correct password in the PASS parameter.
6. Configure loadcells used	Enter the correct number of connected loadcells in the n.Lc. parameter. Enter the correct number of supporting points in the n.Crn. parameter. If a change is made to these parameters, it may be necessary to turn the power off and on.
7. Power off/on and check loadcells	Check that both green TXBB lamps are ON. Check that the yellow TXLC lamp is ON. Check that the red 1 to X lamps are OFF. Verify all loadcells found are without error indications in the Lc. 0 to Lc. X parameters.
8. Unlock parameters once again	Enter the correct password in the PASS parameter.
9. Check system calibration factor	Check the system calibration factor is initially set to 524288 in the CAL.F. parameter.
10. Configure update rate	Enter the desired integration period (update rate in ms) in the Int.PER. parameter.
11. Configure the weighing range	Depending on the used loadcells configure the weighing range unit in the Unit. parameter. Depending on the used loadcells configure the weighing range dpno in the dPno parameter. Depending on the used loadcells configure the weighing range division in the div parameter. The weighing range parameters should match/reflect the actual weighing system and its capacity.
12. Configure the level alarm setpoints	If the level alarms are to be used the setpoints should be configured in the SP. 1 and SP. 2 parameters.
13. Configure the analog output	Use the An.SP. parameter to indicate the load for full-scale signal (normally the total loadcell capacity). Use the An.Err. parameter to indicate the value set on the analog output during errors (normally 20.00mA). Optionally use the An.tESt parameter to check the analog connection. Use the An.tyPE parameter to select signal type controlling analog output (normally LoAd is selected). Check that the red AE lamp is OFF.
14. Configure the Ethernet channel	Use the IP 0 to IP 3 parameters to set the IP address used in the Ethernet communication. Use the Sub.n. 0 to Sub.n. 3 parameters to set the subnet mask used in the Ethernet communication. Use the Port.no. parameter to set the port number used in the Ethernet communication. Use the Eth.nEt. parameter to set signal type controlling the Ethernet channel (normally LoAd is selected).
15. Perform zero	Perform a zero with no load on weighing arrangement using the ZERo parameter or the ZERO input.
16. Perform load check (4x79)	Verify the load indication with a known load using the LoAd parameter.
17. Perform load check (main system)	Verify the load indication on the analog output is transferred correctly to the main control system.
18. Perform system calibration? (Optional)	Optionally perform a system (span) calibration if desired/needed. Note system calibration factor.
19. Perform final load check (Optional)	If necessary verify the load indication in the LoAd parameter is ok using a known load. If necessary verify the load indication in the LoAd parameter is transferred correctly on Ethernet channel. If necessary verify the load indication in the LoAd parameter is represented correctly on the analog output using the OutPut parameter and a measuring instrument. If necessary verify the load indication in the LoAd parameter is transferred correctly to the main control system.
20. Lock parameters	Lock parameter change by setting the password in the PASS parameter to 0.

6.4 Appendix D: 4x79 Parameter list

This application contains the following parameters:

PARAMETER	DESCRIPTION
LoAd	Display current load on loadcells.
OutPut	Display current analog output signal (0.00-20.00mA).
PASS	Display/Change password for unlocking/locking data entry.
ZERo	Request zero of current load indication.
CAL.L.	Display/Change calibration load used.
CAL.	Perform system calibration.
CAL.F.	Display/Change system calibration factor (default is 524288).
n.Lc.	Display/Change number of loadcells connected.
n.Crn.	Display/Change number of supporting corners.
Int.PEr.	Display/Change integration period (measurement time in ms).
Unit	Display/Change weighing range unit (Kg, Lb., Gram, Tons).
dPno	Display/Change weighing range dpno (digits after decimal point).
div	Display/Change weighing range division.
SP. 1	Display/Change setpoint for controlling digital output OUT1.
SP. 2	Display/Change setpoint for controlling digital output OUT2.
An.SP.	Display/Change load value for full analog output signal.
An.Err.	Display/Change analog output value used during error (0.00-20.00).
An.tEst	Enter analog test mode and output different test values (0.00-20.00).
An.tyPE	Display/Change signal type transferred on analog output.
Lc. 0 - Lc. 3	Display individual loadcell signals/status for connected loadcells.
nnAc 0 - nnAc 5	Display MAC address part for the module used during Ethernet communication.
IP 0 - IP 3	Display/Change IP address part for the module used during Ethernet communication.
Sub.n. 0 - Sub.n. 3	Display/Change Subnet mask part for the module used during Ethernet communication.
Port.no.	Display/Change port number for the module used during Ethernet communication.
Eth.nEt.	Display/Change signal type transferred on Ethernet communication.

6.5 Appendix E: Trouble shooting

6.5.1 Trouble shooting – Status code indication

If the 4x79 analog module detects a situation that results in a status code indication different from 0, the 4x79 analog module will output its error value (see **An.Err.** parameter) on its analog output, and the level alarms will both be active, no matter what the current load is. The actual status code will then be shown instead of the actual load in the **LoAd** , **ZErO** and **CAL.** parameters. It will then be possible to use the **Lc. X** parameter to try and locate the error.

6.5.2 Trouble shooting – Analog output error

If the build-in Digital to Analog Converter (DAC) detects an over temperature or detects that the analog output signal is different from its programmed value, then the **AE** light emitting diode will be lit. This will for example be the case if the current-loop is broken in a system where the module is in its current configuration.

6.6 Appendix F: Actual filter characteristics

The filter frequency depends on the weight display reading update rate (integration period). Examples are given in the table below depending on the filter number selected using the DIP switches as previously described:

Update period (ms)			20	100	200	400
Filter			Filter frequency (Hz) and total settling time (ms/s)			
No.	Taps	Damping				
0	-	-	No filter enabled			
1	7	-60dB	12 Hz 140 ms	2,4 Hz 700 ms	1,2 Hz 1,4 s	0,6 Hz 2,8s
2	9	-60dB	10 Hz 180 ms	2,0 Hz 900 ms	1,0 Hz 1,8 s	0,5 Hz 3,6 s
3	9	-80dB	12 Hz 180 ms	2,4 Hz 900 ms	1,2 Hz 1,8 s	0,6 Hz 3,6 s
4	12	-60dB	8 Hz 240 ms	1,6 Hz 1,2 s	0,8 Hz 2,4 s	0,4 Hz 4,8 s
5	12	-80dB	10 Hz 240 ms	2,0 Hz 1,2 s	1,0 Hz 2,4 s	0,5 Hz 4,8 s
6	15	-80dB	8 Hz 300 ms	1,6 Hz 1,5 s	0,8 Hz 3 s	0,4 Hz 6 s
7	17	-60dB	6 Hz 340 ms	1,2 Hz 1,7 s	0,6 Hz 3,4 s	0,3 Hz 6,8 s
8	21	-80dB	6 Hz 420 ms	1,2 Hz 2,1 s	0,6 Hz 4,2 s	0,3 Hz 8,4 s
9	25	-60dB	4 Hz 500 ms	0,8 Hz 2,5 s	0,4 Hz 5 s	0,2 Hz 10 s
10	32	-80dB	4 Hz 640 ms	0,8 Hz 3,2 s	0,4 Hz 6,4 s	0,2 Hz 12,8 s
11	50	-60dB	2 Hz 1,0s	0,4 Hz 5 s	0,2 Hz 10 s	0,1 Hz 20 s
12	64	-80dB	2 Hz 1,28 s	0,4 Hz 6,4 s	0,2 Hz 12,8 s	0,1 Hz 25,6 s
13	67	-60dB	1,5 Hz 1,34 s	0,3 Hz 6,7 s	0,15 Hz 13,4 s	0,075 Hz 26,8 s
14	85	-80dB	1,5 Hz 1,70 s	0,3 Hz 8,5 s	0,15 Hz 17 s	0,075 Hz 34 s
15	100	-60dB	1 Hz 2,0 s	0,2 Hz 10 s	0,1 Hz 20 s	0,05 Hz 40 s

6.7 Appendix G: Status Codes

Status codes can be shown as a 4 digit hex number (“-XXXX-”) instead of the actual load indication in the **LoAd** , **ZEro** , **CAL.** and **LC. X** parameters. If more than one of the status conditions listed below is present, the status codes are OR’ed together.

CODE (Hex)	CAUSE
0001	<i>Reserved for future use</i>
0002	<i>Reserved for future use</i>
0004	<i>Reserved for future use</i>
0008	<i>Reserved for future use</i>
0010	Power failure Supply voltage to loadcells is too low.
0020	<i>Reserved for future use</i>
0040	<i>Reserved for future use</i>
0080	No answer from loadcell Bad connection between loadcell and 4015 loadcell module? Bad connection between 4015 loadcell module and 4040 communication module? Bad connection between 4040 communication module and 4079 module? Bad setting of DIP switches on 4040 communication module?
0100	<i>Reserved for future use</i>
0200	<i>Reserved for future use</i>
0400	<i>Reserved for future use</i>
0800	No loadcell answer Bad connection between 4040 communication module and 4079 module?
1000	<i>Reserved for future use</i>
2000	<i>Reserved for future use</i>
4000	<i>Reserved for future use</i>
8000	Wrong number of loadcells The expected number of loadcells found during power-on does not match the number indicated by the n.Lc. parameter. If the n.Lc. parameter setting is correct, it must be examined that the setting of DIP switches on the 4040 communication module is correct.

Please note that the above listed status codes are valid when the 4040 communication module is equipped with standard program.