

5024G

Options Guide

Ethernet-IP

5024G LCD weighing terminal

Ethernet-IP option: Direct connection



Software: StdLim.140630.6v3i
Doc. no.: StdLim-140630-6v3-OG-EthNetIP-eng
Date: 2022-11-28
Rev.: 6v3

Contact:
Eilersen Electric A/S
Kokkedal Industripark 4
DK-2980 Kokkedal
Denmark
www.eilersen.com
info@eilersen.com
Tel: +45 49 180 100
Fax: +45 49 180 200

Contents

Contents.....	2
Introduction	4
How to	4
– Configure Ethernet-IP settings on 5024G	4
Address settings.....	4
Enable Ethernet-IP protocol.....	5
– Check EtherNetIP communication status.....	5
Protocol description	6
– Ethernet-IP communication using PPO	6
– MOD	7
MDS.....	7
– PCV Description.....	7
PCA.....	7
PNU	8
PVA.....	8
– PCD Description.....	8
CTW/STW	8
MRV/MAV	9
– Communication overview	9
– RS – Reference Value Selector, MRV – Main Reference Value	9
– AS – Actual Value Selector, MAV – Main Actual Value	9
– CTW – Control Word	10
– STW – Status Word.....	10
– Parameters	11
Trouble shooting.....	13
Appendices	14
Appendix A – Screens overview	14
Appendix B – Electrical connection of 5024G to Ethernet-IP	14
Ethernet communication connector on 5024G	14
Appendix C – 5024G Ethernet-IP specification	15

Appendix D – Ethernet-IP connection to Allen Bradley	15
Ethernet-IP communication – Master input	16
Ethernet-IP communication – Master output	16
Appendix E – Ethernet-IP status indications	16
Revision History	17
Contact.....	17

Introduction

This document describes the use of the Ethernet-IP option on the 5024G Weighing Terminal from Eilersen Electric. With the software version stated on the front page and with the Ethernet-IP option enabled the system can communicate with an external controller/PLC using Ethernet-IP.

With the stated software version installed the 5024G terminal can transfer 14 input bytes from the 5024G terminal to the Ethernet-IP master, and transfer 14 output bytes from Ethernet-IP master to the 5024G terminal.

Exchange of data between 5024G terminal and the external controller/PLC is made according to the profile/protocol described later (see *Protocol description*).

This manual only describes the Ethernet-IP option. For general information on the operation of the 5024G please see the 'Users guide'.

How to

– Configure Ethernet-IP settings on 5024G

For the terminal to perform Ethernet-IP communication directly on its RJ45/Cat5 Ethernet connector (J7) with a connected Ethernet-IP master the Ethernet settings must be configured, and the Ethernet-IP protocol must be enabled as described in the following.

Address settings

Ip addresses, subnet masks etc. are normally set from a PC with the EEConnect software. Please refer to the EEConnect documentation for further details.

If the terminal is unreachable e.g. due to network topology, the Ethernet settings can be entered in the **SETUP ETHERNET** screen:

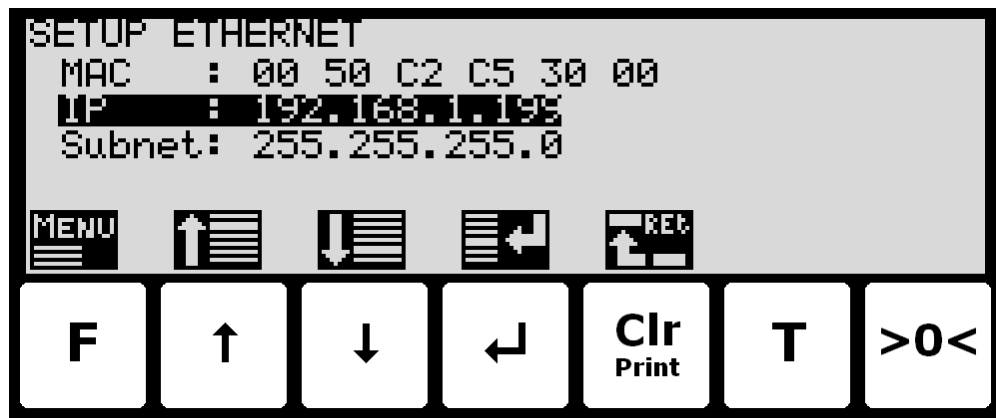

Enable Ethernet-IP protocol

The Ethernet-IP protocol must be enabled. This is done in the **ETHERNET PROTOCOLS** screen shown below:

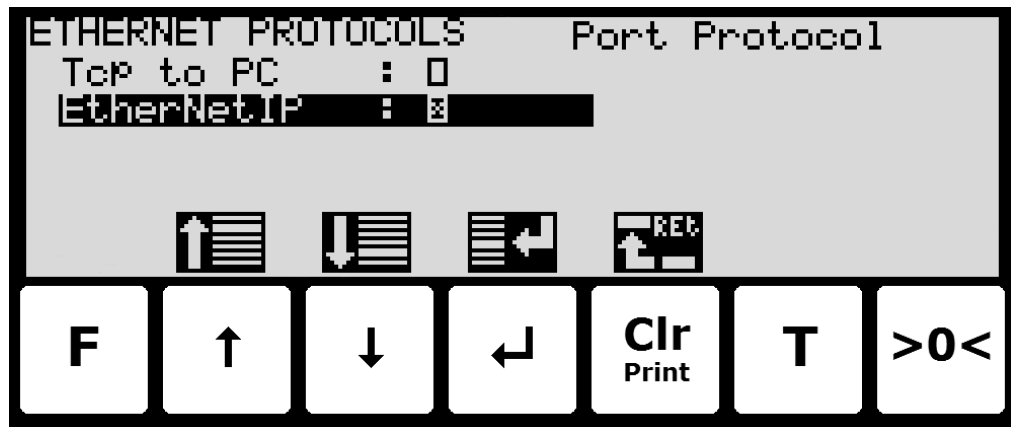

In the **ETHERNET PROTOCOLS** screen the 'EtherNetIP' parameter is selected using the cursor, and  is pressed to enable or disable the Ethernet-IP protocol. A X in the corresponding box indicates the protocol is enabled.

– Check EtherNetIP communication status

In the **ETHERNET STATUS** screen, the status of the EtherNetIP communication can be read:

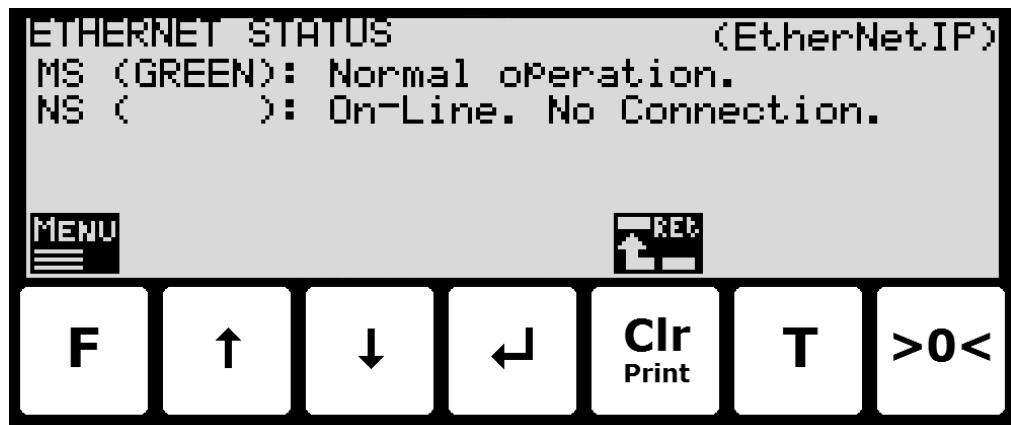

This requires that the EtherNetIP protocol is selected from the menu (the  key) in the **ETHERNET STATUS** screen. The currently selected protocol is shown in the upper right corner of the screen. If the *EtherNetIP* protocol is selected, then the EtherNetIP status indications for both Module Status (**MS**) and Network Status (**NS**) are shown, corresponding to the normal **MS** and **NS** lamps as follows:

- their respective color (in parenthesis): which can be lit, flashing or turned off (blank).
- and a following short explanatory status text.

The Module Status (**MS**) and Network Status (**NS**) indications can be lit/flashing in different colors depending on module and network status. Please see **Appendix E – Ethernet-IP status indications** for a more detailed explanation of the different/possible status indications.

Protocol description

– Ethernet-IP communication using PPO

The Ethernet-IP communication is made using a 'parameter-process data object' (PPO) consisting of 14 bytes data. This telegram (object) is used during both reception and transmission of data. The structure of this telegram is as follows:

MOD		PCV						PCD					
MDS	PCA	PNU			PVA			CTW		MRV			
								STW		MAV			
1	2	3	4	5	6	7	8	9	10	11	12	13	14

Byte 1

Byte 14

The telegram is made up of 3 blocks; a MOD part (1 byte), a PCV part (the next 7 bytes) and a PCD part (the last 6 bytes). The three blocks are as follows:

MOD (Mode)

MDS (Byte 1): Mode selector

PCV (Parameter-Characteristic-Value)

PCA (Byte 2): Parameter Characteristics

PNU (Bytes 3-4): Parameter number

PVA (Bytes 5-8): Parameter value

PCD (Process Data)

CTW (Bytes 9-10) (Master to Slave): Control Word

STW (Bytes 9-10) (Slave to Master): Status Word

MRV (Bytes 11-14) (Master to Slave): Main Reference Value

MAV (Bytes 11-14) (Slave to Master): Main Actual Value

In the following the meaning of the individual blocks of the telegram is explained further.



IMPORTANT: During transfer/reception of data (i.e. the MAV) it is up to the master (the PLC) to ensure consistent data, when a parameter consisting of several bytes is read/updated and when AS/MAV or RS/MRV is read/set.

– MOD

The MOD part of the telegram indicates which value is to be transferred as **Main Reference Value** (MRV) and as **Main Actual Value** (MAV). Please see below for further information.

MDS

MDS contains an RS part for selection of **Main Reference Value** (MRV) and an AS part for selection of **Main Actual Value** (MAV), as shown in the figure below.

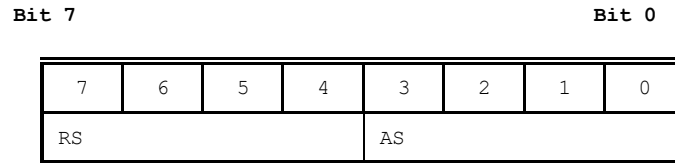

RS: Reference value selector (Values: 0..15)

AS: Actual value selector (Values: 0..15)

– PCV Description

The PCV part of the telegram is made up of a PCA part, a PNU part and a PVA part. The function of these different parts of the PCV part is described here.

PCA

The PCA part contains an RC part for 'request' and 'response' indication.

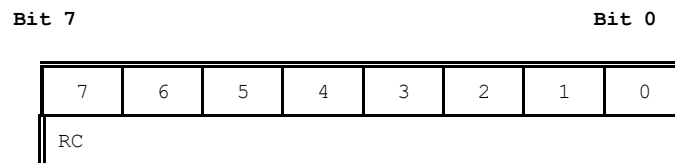

RC: Request/Response Characteristics (Values: 0..255)

RC is used by the master to tell the slave which 'request' is desired. Similarly the slave uses RC to inform the master the status of the received 'request' ('response'). The contents of RC has the following function during 'request':

REQUEST	FUNCTION
0	No request
1	Request parameter value
2	Change parameter value (2 bytes)
3	Change parameter value (4 bytes)
<i>Others</i>	<i>Reserved for future use</i>

The contents of RC has the following function during response:

RESPONSE	FUNCTION
0	No response
1	Transfer parameter value (2 bytes)
2	Transfer parameter value (4 bytes)
3	Request rejected (incl. Error#, see later)
4	Cannot be serviced by PCV interface
<i>Others</i>	<i>Reserved for future use</i>

PNU

The PNU part indicates the parameter number of the parameter to be read/changed. The parameters and their function is described below.

PVA

The PVA part contains 4 bytes for reception and transmission of parameter values. The PVA part transfers '2 byte' parameters in bytes 5 and 6, while '4 byte' parameters are transferred in bytes 5 and 8.

If the slave rejects a request from the master the RC part assumes the value 3 (see above) and the error number itself is transferred in the PVA part (bytes 5 and 6). The following error indications are possible:

ERROR #	CAUSE
0	Illegal command for this PNU or PNU not used.
1	<i>Reserved for future use</i>
2	Upper or lower limit exceeded

– PCD Description

The PCD part of the telegram is made up of a CTW/STW part and a MRV/MAV part. The function of these two parts of the PCD part is described here. Note that the PCD part (the last 6 bytes) always transfers these data disregarding the contents of the PCV part.

CTW/STW

During communication from the master to the slave, the first two bytes of the PCD part are used as a Control Word (CTW). Using the Control Word (CTW) it is possible to tell the slave how to react as different commands can be transferred to the slave.

During communication from the slave to the master, the first two bytes of the PCD part are used as a Status Word (STW). Using the Status Word (STW) it is possible for the master to gain information on the status of the slave.

MRV/MAV

During communication from the master to the slave the last four bytes of the PCD part are used as a **Main Reference Value** (MRV); a setpoint. Using the RS defines exactly which value is transferred as MRV.

During communication from the slave to the master the last four bytes of the PCD part are used as a **Main Actual Value** (MAV); the actual value. Using the AS defines exactly which value is transferred as MAV.

– Communication overview

Please note the following:

1. All weights are transferred as shown in the display without a decimal point (i.e. 300.0 kg is transferred as 3000 and 67.2 kg is transferred as 672).
2. All negative numbers are transferred as 2-complement numbers.
3. Actual unit and decimal point position can be read from the appropriate parameter.
4. In Ethernet-IP communication the Endian used is LSB (Least Significant Byte first).

– RS – Reference Value Selector, MRV – Main Reference Value

RS	MRV
Reference Value Selector	Main Reference Value
0	Not used
Others	Not used

– AS – Actual Value Selector, MAV – Main Actual Value

AS	MAV
Actual Value Selector	Main Actual Value
0	Not used
1	Actual gross weight
2	Actual net weight
Others	Not used

Actual gross weight is the actual gross weight on the 5024G terminal.

Actual net weight is the actual net weight on the 5024G terminal.

- CTW – Control Word

Bit	Function
0	Zero
1	Autotare (zero of net weight)
2	Start dosing
3	Stop dosing
4	Registration
<i>Others</i>	<i>Not used</i>

Zero must be activated if a zero of the gross weight is desired.

Autotare must be activated if a zero of the net weight is desired.

Start dosing must be activated if a start of dosing is desired.

Stop dosing must be activated if a dosing is to be stopped before the fine limit is reached. If the terminal is set to perform automatic registration on time this will take place afterwards.

Registration must be activated if a registration of the actual net weight is desired. Any dosing in progress will be aborted before registration.

- STW – Status Word

Bit	Function
0	Weight reading not possible
1	Zero OK
2	Zero not possible
3	Autotare OK
4	Autotare not possible
5	Start dosing OK
6	Start dosing not possible
7	Stop dosing OK
8	Stop dosing not possible
9	Registration OK
10	Registration not possible
11	Fine dosing
12	Coarse dosing
13	<i>Not used</i>
14	Registration ready
15	OK – always ON

Weight reading not possible is active when the 5024G terminal is unable to determine weight.

Zero OK is active when zero was possible.*)

Zero not possible is active when zero was NOT possible.*)

Autotare OK is active when autotare was possible.*)

Autotare not possible is active when autotare was NOT possible.*)

Start dosing OK is active when start of dosing was possible.*)

Start dosing not possible is active when start of dosing was NOT possible.*)

Stop dosing OK is active when stop of dosing was possible.*)

Stop dosing not possible is active when stop of dosing was NOT possible.*)

Registration OK is active when registration of net weight was possible.*)

Registration not possible is active when registration of net weight was NOT possible.*)

Fine dosing is active during dosing until the fine limit (pos. adjusted for afterflow) is reached.

Coarse dosing is active during dosing when the net weight is below the coarse limit.

Registration ready is active when a registration is ready. The bit is cleared when a new dosing is started.

OK – always ON is always activated. Can be used as a control of the communication.

Bits marked with *) are cleared again when the corresponding request bit is cleared.

– Parameters

NO	TYPE	PARAMETER
1	4, R	Actual gross weight
2	4, R	Actual net weight
3	4, RW	Fine limit
4	4, RW	Coarse limit
5	-	<i>Not used</i>
6	4, R	Last registered amount
7	4, R	Total dosed amount
8	4, R	Total number of weighings
10	2, R	Unit <i>0: kg</i> <i>1: lbs</i> <i>2: gram</i>
11	2, R	Decimal point position
20 - 35	2, R	Load cell-Status[x]
40 - 55	4, R	Load cell-Gross[x]
<i>Others</i>		<i>Not used</i>

Actual gross weight is the actual gross weight on the 5024G terminal.

Actual net weight is the actual net weight on the 5024G terminal.

Fine limit contains the fine limit used during dosing.

Coarse limit contains the coarse limit used during dosing.

Last registered amount contains the result (registration) of the last dosing.

Total dosed amount contains the total dosed amount.

Total number of weighings contains the total number of weighings.

Unit indicates the unit used in the display reading. It should be used to scale weight indications received/transmitted using the Ethernet-IP communication.

Decimal point position indicates the number of digits after the decimal point in the display reading. It should be used to scale weight indications received/transmitted using the Ethernet-IP communication.

Load cell-Status[x] contains the actual status for load cell x.

Load cell-Gross[x] contains the actual gross signal (not zeroed) on load cell x.

Appendices

Appendix A – Screens overview

The system has the following screens, which are selected using the menu system.

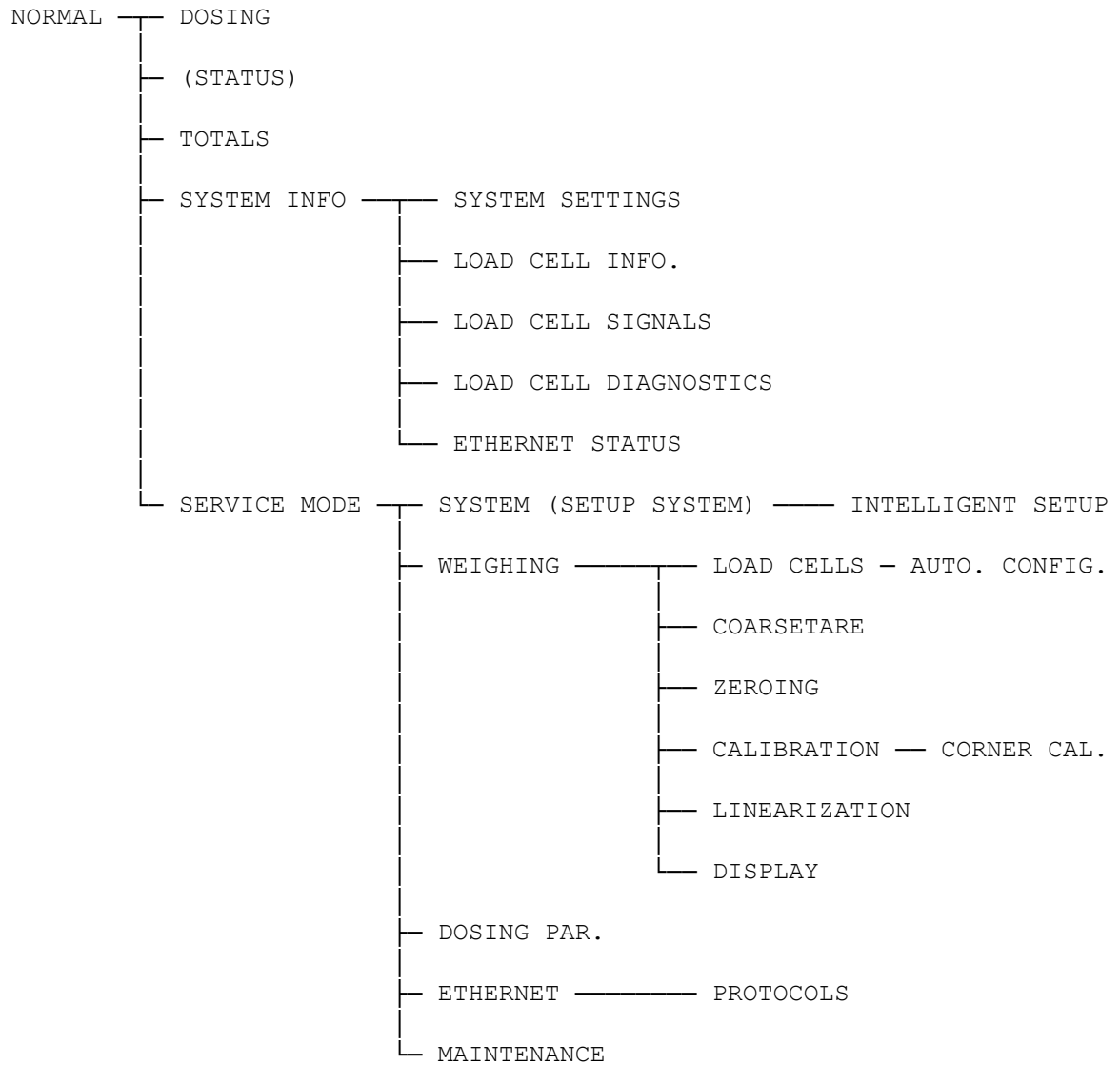

Appendix B – Electrical connection of 5024G to Ethernet-IP

The following describes the electrical connection of the 5024G terminal to Ethernet-IP.

Ethernet communication connector on 5024G

The RJ45/Cat5 Ethernet connector (J7) on the backside of the 5024G terminal is a standard Ethernet connector that is used to connect the 5024G system to the Ethernet-IP master.

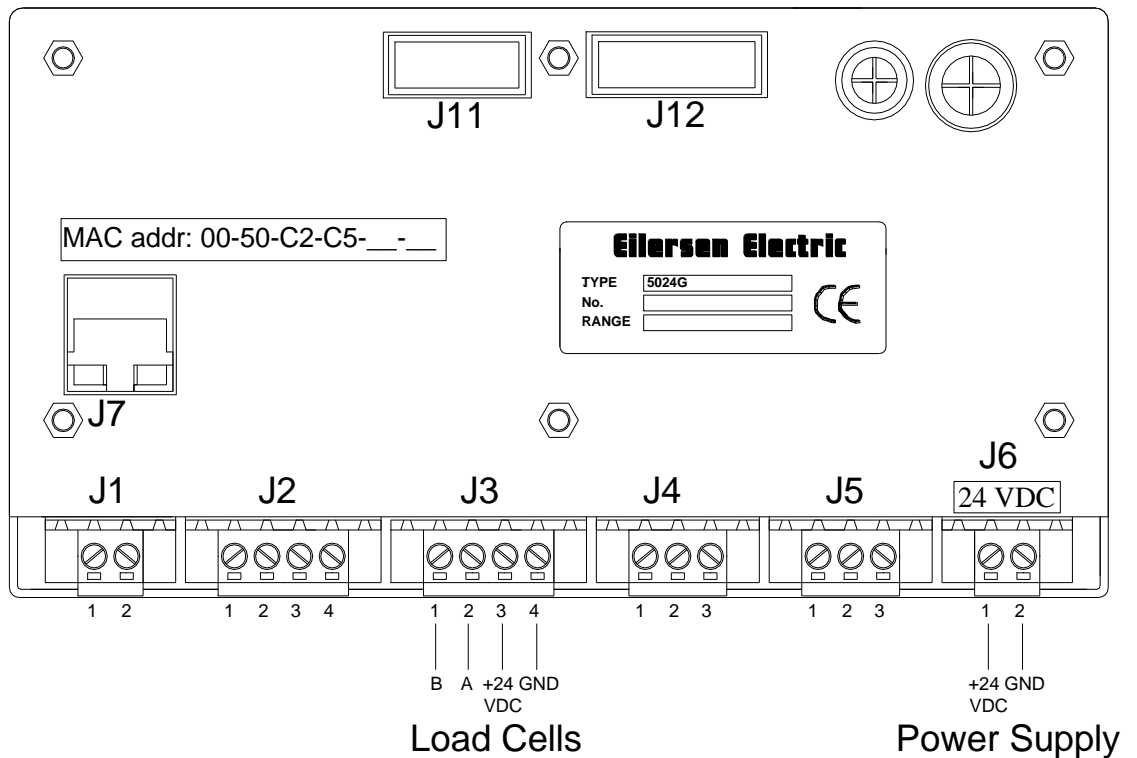

Appendix C – 5024G Ethernet-IP specification

The 5024G terminal confirms with the following Ethernet-IP specifications:

Protocol:	Ethernet-IP
Media:	Ethernet
Module type:	Slave(/Target)
Communication settings	10MB/s, Half duplex
IP-Address:	Fixed (default: 192.168.1.199)
Ethernet connection:	RJ45/Cat5
System setup:	Ethernet by use of EEConnect program, or by use of SET-UP ETHERNET screen

Appendix D – Ethernet-IP connection to Allen Bradley

To connect the 5024G terminal with Ethernet-IP protocol to an Allen Bradley (Rockwell Automation) PLC using the Logix 5000 software the following must be observed:

1. Use the "ETHERNET MODULE Generic Ethernet Module
2. Do **NOT** use unicast, always use multicast.
3. Set connection format to "SINT"
4. Set "Input" "Assembly instance to 103, "Size" 14 (8-bit)
5. Set "Output" "Assembly instance to 102, "Size" 14 (8-bit)
6. Set "Configuration" "Assembly instance to 101, "Size" 1 (8-bit)

Ethernet-IP communication – Master input

Ethernet-IP communication from the 5024G terminal uses a single Assembly consisting of 14 bytes data as specified in the EDS file:

Assembly:	Assem3	Input
Assembly instance:	103	(0x67)
Connection:	Connection1	Exclusive Owner
Transfer class	Class 1	

The data bytes transferred to the master (PLC) using this assembly, are structured and used as previously described.

Ethernet-IP communication – Master output

Ethernet-IP communication to the 5024G terminal uses a single Assembly consisting of 14 bytes data as specified in the EDS file:

Assembly:	Assem2	Output
Assembly instance:	102	(0x66)
Connection:	Connection1	Exclusive Owner
Transfer class	Class 1	

The data bytes transferred from the master (PLC) using this assembly, are structured and used as previously described.

Appendix E – Ethernet-IP status indications

The different Module Status (MS) and Network Status (NS) indications in the **ETHERNET STATUS** screen can be used along with the following table to determine the actual status of the EtherNetIP communication:

Indication	Color	Status	Description
MS	Green	ON	Normal Operation. Communication performed normally.
		Flashing	Standby State. The unit needs supervision.
	Red	ON	Unrecoverable fault. A timer error, memory error or other system error. The unit may need replacing.
		Flashing	Recoverable fault. Configuration error, DIP-switch not set correct, IP-Address error or similar error. Correct error and restart unit.
---	OFF	No power. The power is disconnected or the unit is being restarted.	
NS	Green	ON	On-Line, Connection OK. The unit is On-Line and a connection with the master has been established.
		Flashing	On-Line, No Connection. The unit is On-Line but no connection to the master has been established.
	Red	ON	Critical Communication Error. The unit has detected an error that makes it impossible to communicate on the network.
		Flashing	Communication Time-Out. One or more I/O connections are in the Time-Out state.
	---	OFF	No power/Off-line. The device may not be powered.

Revision History

Date	Author	Rev.	Update
2018-11-28	HJA	4v0	<i>Initial document created and adapted. (based on StdLim-140630-3v0-OG-EthNetIP-eng)</i>
2019-01-10	HJA	5v0	<i>Based on StdLim-140630-4v0-OG-EthNetIP-eng, but: Adapted screens overview in Appendix A.</i>
2019-02-19	HJA	5v1	<i>Updated references to software ID.</i>
2019-04-24	jk	5v2	<i>Updated references to software ID.</i>
2019-05-20	jk	5v3	<i>Updated references to software ID.</i>
2019-09-03	HJA	5v4	<i>Added Intelligent Setup to screens overview.</i>
2020-02-18	HJA	5v6	<i>Added ETHERNET STATUS screen and EtherNetIP status indications.</i>
2020-09-08	HJA	5v7	<i>Updated references to software ID.</i>
2021-02-11	HJA	5v8	<i>Updated references to software ID.</i>
2021-05-07	HJA	6v0	<i>Updated references to software ID.</i>
2021-11-12	HJA	6v0a	<i>Added MAINTENANCE screen to screens overview.</i>
2022-01-19	HJA	6v1	<i>Updated references to software ID.</i>
2022-03-29	HJA	6v2	<i>Updated references to software ID.</i>
2022-11-28	HJA	6v3	<i>Updated references to software ID.</i>

Contact

With further questions or improvement suggestions please contact us:

Eilersen
The Weighing Experts

Eilersen Electric A/S
Kokkedal Industripark 4
DK-2980 Kokkedal
Denmark
www.eilersen.com
info@eilersen.com
Tel: +45 49 180 100
Fax: +45 49 180 200

Eilersen
The Weighing Experts