

5024G

Options Guide

Remote Display

5024G LCD weighing terminal

Remote display: 5024 remote display using remote display option



Software: StdLim.140630.6v7r
Doc. no.: StdLim-140630-6v7-OG-RemDisp-eng
Date: 2024-09-02
Rev.: 6v7

Contact:
Eilersen Electric A/S
Kokkedal Industripark 4
DK-2980 Kokkedal
Denmark
www.eilersen.com
info@eilersen.com
Tel: +45 49 180 100
Fax: +45 49 180 200

Contents

Contents.....	2
Introduction	4
Installation of 5024G remote display	4
How to	5
– Enable and configure remote display on 5024G.....	5
Enable or change Display Type	5
Set/Read Display Address	5
Set/Read Endian.....	5
Read Status	5
Read Error Counter	6
Set/Read Bytes Out.....	6
Set/Read Bytes In.....	6
Enable/Disable keys on remote display	6
– Monitor external display data on 5024G	6
Operating 5024 remote display	7
– Basic operations	7
– Operate the menu system.....	8
- Unlock the keyboard.....	8
- Unlock for parameter update	9
- Set amount of communications data.....	9
Set Bytes From Host.....	9
Set Bytes To Host	9
– Check the software version.....	10
Trouble shooting.....	11
Appendices	12
Appendix A – 5024G Main Display: Screens overview	12
Appendix B – 5024G Remote Display: Screens overview	13
Appendix C – 5024G Main Display: Electrical connection.....	13
5024G Main Display: RS485 communication connector.....	13
Appendix D – 5024G Remote Display: Electrical connection.....	14

5024G Remote Display: Rear view	14
5024G Remote Display: Power Connection	14
5024G Remote Display: RS485 communication	15
Revision History	16
Contact.....	16

Introduction

This document describes the use of the Remote Display option on the 5024G Weighing Terminal from Eilersen Electric when used for connecting a 5024G remote display. With the software version stated on the front page installed in the 5024G main terminal, and with the Remote Display option enabled, as well as a on RS485 externally connected 5024G remote display from Eilersen Electric, the system can on the remote display show weight indications (gross/net weight) and possibly perform zeroing of these from its keyboard.

IMPORTANT: In order for communication between 5024G main terminal and 5024G remote display to be established, it is necessary, that the amount of data bytes exchanged between main terminal and remote display is set on both displays, as described in the following.



NOTICE: All other configuration, setup, error finding and electrical connection (apart from the connections listed in this manual) **MUST** be made on the 5024G main terminal.

This manual only describes the Remote Display option and operation from the 5024G remote display. For general information regarding operation of the 5024G main terminal please see the separate 'Users guide'.

Installation of 5024G remote display



The used remote display (**5024G**) must be connected to the 5024G main terminal according to the description in the appropriate appendix.

Please notice: The 5024G remote display is connected to the 5024G main terminal using a RS485 connection.

How to

– Enable and configure remote display on 5024G

Below the **REMOTE DISPLAY** screen is shown when a 5024G remote display has been enabled on the 5024G main terminal.

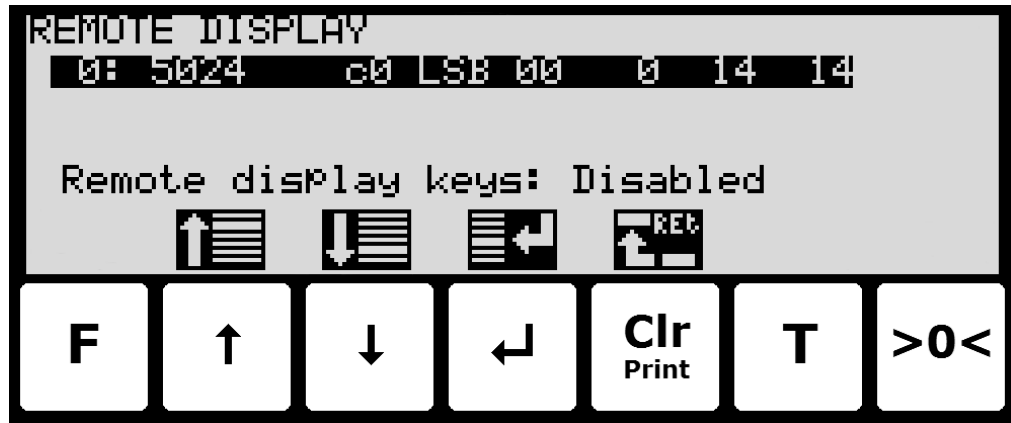

In this screen the enabled external devices are shown and can be changed. A cursor (inverted text) indicates the currently selected device. With this version of the software only one remote display can be installed.

The line with module/display data shows in forth running order after the Device Index: Device Type, Device Address, Endian, Status, Error Counter, Bytes Out and Bytes In, which all are described in detail below.

Enable or change Display Type

To enable or select a new display type press  on the selected line, and from the **REMOTE DISPLAY** menu select the **DISPLAY TYPE** menu item to get the selection list with possible display types. Possible display types are **5024** display. If no remote display is enabled the 5024G display will show "-----" / "None".

Once a display type is enabled/selected the other settings (see descriptions below) are set to default values, which should normally be used.

Set/Read Display Address

The address is the entered address plus the base address for the display type selected.

During change enter a number in the interval 0-15. With this software version where only one remote display can be connected, 0 is the normal entered value for a total address of **c0**.

Set/Read Endian

Endian of the individual data values transferred: *MSB* most significant byte first: Big endian. *LSB* least significant byte first: Little endian. Normally *LSB* is used with the Remote Display option.

Read Status

00: Communication up and running.

40: Connection established earlier to the device has been lost.

80: No connection to the device has been established.

Read Error Counter

Current number off errors in communication.

Set/Read Bytes Out

Number of bytes to be sent from the 5024G to the external remote display.

The value must be the same as the value in the external remote display.

Normally this is 14 or 16.

NOTE: In this application 14 is used.

Set/Read Bytes In

Number of bytes to be received in the 5024G from the external remote display.



The value must be the same as the value in the external remote display.

Normally this is 14 or 16.

NOTE: In this application 14 is used.

Enable/Disable keys on remote display

By moving the cursor onto the **Remote display keys** parameter it is then possible by pressing

 to enable/disable important keys ( and ) in the **NORMAL** screen of the 5024 remote display.

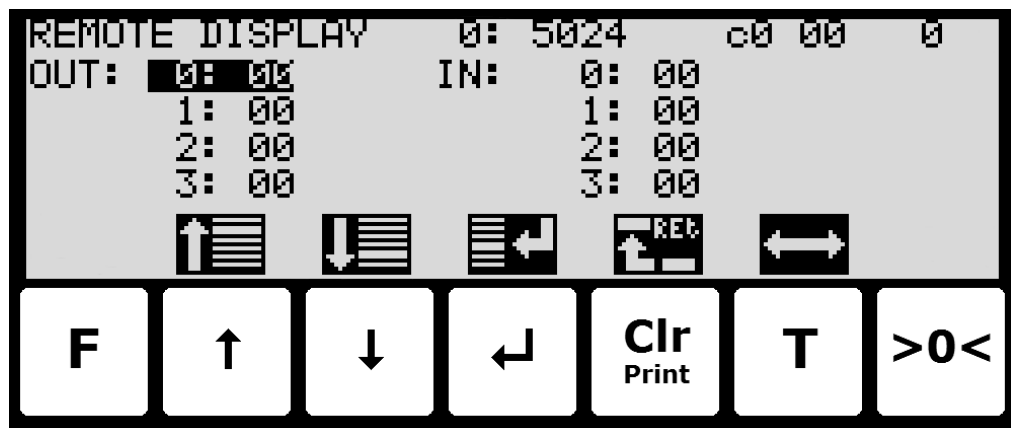

– Monitor external display data on 5024G

Below the **REMOTE DISPLAY DATA** screen is shown when a 5024G remote display has been enabled and chosen on the 5024G main terminal.



This screen will show the data sent to the external device (*OUT*) and the data received from the external device (*IN*).

The following keys can be used for the described special functions:

-  Selects entry of the selected input data byte for test purposes. If an external device is communicating the value will immediately be overwritten by the value received from the external device.
-  Toggles the cursor between the output and the input bytes.

Operating 5024 remote display

– Basic operations

When the power-up sequence has ended the remote display will look like this:

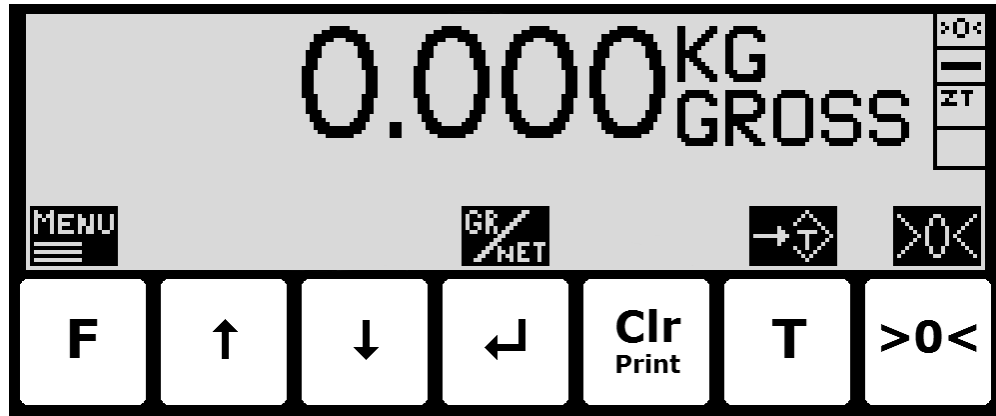

Weight reading:

- The actual weight reading is displayed in large types.
- To the right of the weight reading, the unit is indicated, like **KG**, **LB** etc.
- Below the unit gross/net selection is indicated with **GROSS** or **NET**.
- If an error is present the weight reading will indicate error, like **UL**, **OL**, - **0080** – etc.
- If an error in communication with 5024G main terminal occurs the weight reading is replaced by “-----”.





Status indications:

- ‘>0<’ in the upper right corner status field indicates that the actual gross weight is zero (within $\pm \frac{1}{4}$ division).
- ‘--’ in the second status field indicates that the weight reading is steady/stable. If the reading is unstable ‘~’ will be indicated.
- ‘ZT’ in the third status field indicates that a zero tracking device is active, holding the actual gross weight at zero.
- ‘SP’ in the fourth status field if automatic dosing is running.
- ‘R’ in the fourth status field if registration is in progress.

Please notice: If none of the icons directly above the keys are visible as shown in the screen shot above, the keyboard is locked, since the **Keyboard unlock length** parameter in the **SETUP SYSTEM** screen has been activated. As long as the keyboard is locked, no keyboard actions will be available. Please see below in section - *Unlock the keyboard*, page 8 on how to unlock the keyboard.







Keys/actions:

- | | |
|---|---|
|  | Invoke the MAIN menu. |
|  | Switch between Gross and Net reading. |
|  | Zeroes the net weight if the key is enabled from the 5024G main terminal. |
|  | Zeroes the gross weight if the key is enabled from the 5024G main terminal. |

- Operate the menu system

The installation and service of the system is operated by a series of menus and screens.

When using screens these keys are typically used as follows:

-  Select a menu depending on the actual screen.
-  Increase a value, select previous parameter or move cursor up in a menu.
-  Decrease a value, select next parameter or move cursor down in a menu.
-  Select entry or accept of a value, or select an action from a menu.
-  Return to previous screen. Exit menu without action.



NOTE: See *User's Guide* for further information regarding operation of the 5024 terminal.

- Unlock the keyboard

The terminal is equipped with a keyboard lock feature, which can be enabled or disabled using the **Keyboard unlock length** parameter in the **SYSTEM** screen. If the keyboard lock is disabled, then the keyboard functions will always be active. If the keyboard lock is enabled, and the terminal is in the **NORMAL** screen without any key activation for 10 minutes (or directly after power-on), the keyboard will automatically lock. When the keyboard is locked, the **NORMAL** screen will appear as follows without any icons above the keys:

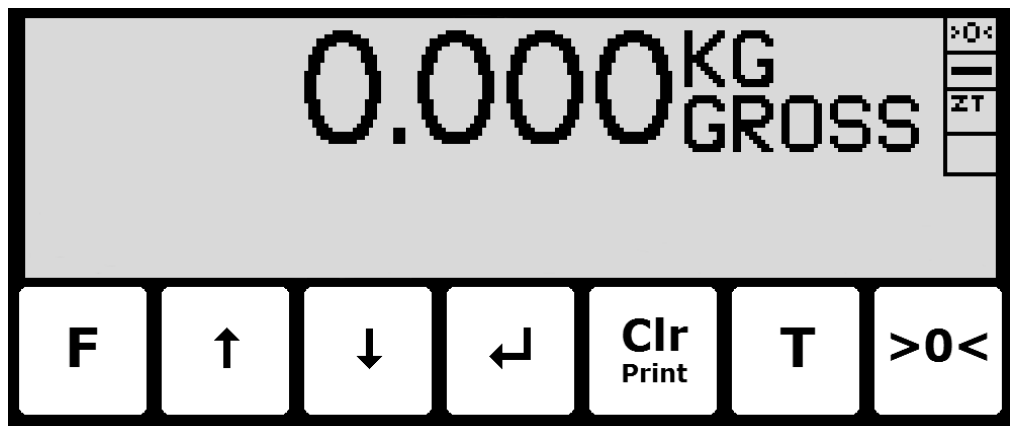

To unlock the keyboard:

- Press any key to start the keyboard unlock sequence.
- Press the indicated keys one at a time until the required sequence (specified by the **Keyboard unlock length** parameter) is completed without error.



Please notice: This feature is disabled by setting the **Keyboard unlock length** parameter in the **SYSTEM** screen to 0. Any other value specifies the length of the key sequence that must be pressed correctly to unlock a locked keyboard.

- Unlock for parameter update

Parameters cannot be changed and actions not performed when the system is powered on. Before such operations are possible the parameters must be unlocked:

- Press **F** to invoke the menu system.
- Press **↓** to highlight the **SERVICE MODE** menu item.
- Press **↵** to select the **SETUP** screen.
- Press **F** to invoke the menu where the **SYSTEM** menu item is highlighted.
- Press **↵** to select the **SYSTEM** screen.
- Press **↓** to highlight the **Parameters** entry.
- Press **↵** to select the **ENTER UNLOCK PARAM** parameter entry.
- Enter the password 1357 and press **↵**. Parameters are now unlocked and can be changed. Press **Clr Print** once to return to the **SETUP** screen or twice to return to the **NORMAL** screen.

The status automatically returns to **LOCKED** after 5 minutes without keyboard activity in **NORMAL** screen or when the terminal is power-cycled.

- Set amount of communications data

The amount of data exchanged between 5024G main terminal and 5024G remote display must be set in the **SETUP SYSTEM** screen on the remote display:

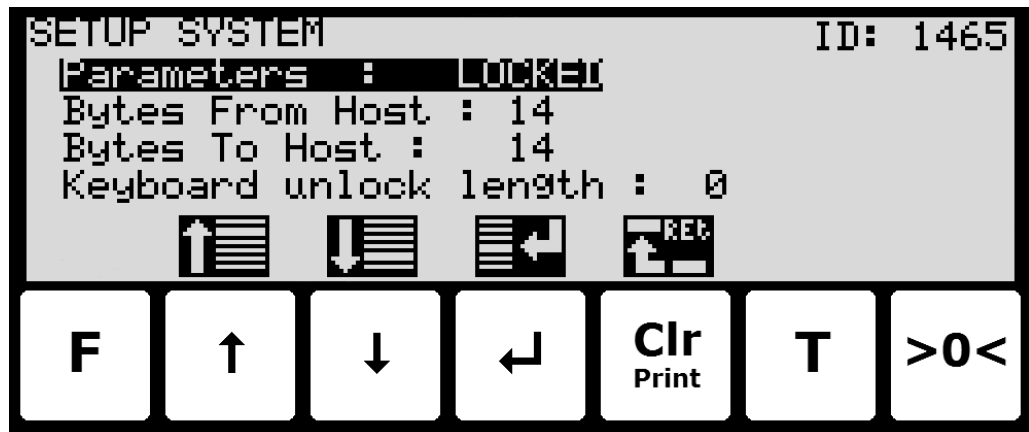

Set Bytes From Host

The number of bytes the remote display receives from the main terminal (Host) MUST be set and be the same as what the main terminal actually transmits. This is normally 14 or 16.

NOTE: In this application 14 is used.

Set Bytes To Host

The number of bytes the remote display transmits to the main terminal (Host) MUST be set and be the same as what the main terminal actually expects. This is normally 14 or 16.

NOTE: In this application 14 is used.

– Check the software version

The software version can be checked during the power-on sequence or in the **SYSTEM INFO** or **SETUP** screen. When power is applied to the system, the following will happen:

- The display will show the logo for 5 seconds.
- The display will show the software version (software name, date and revision).
- The weighing terminal is ready and enters the **NORMAL** screen.

Select the **SYSTEM INFO** screen to read the software version (software name, date and revision):

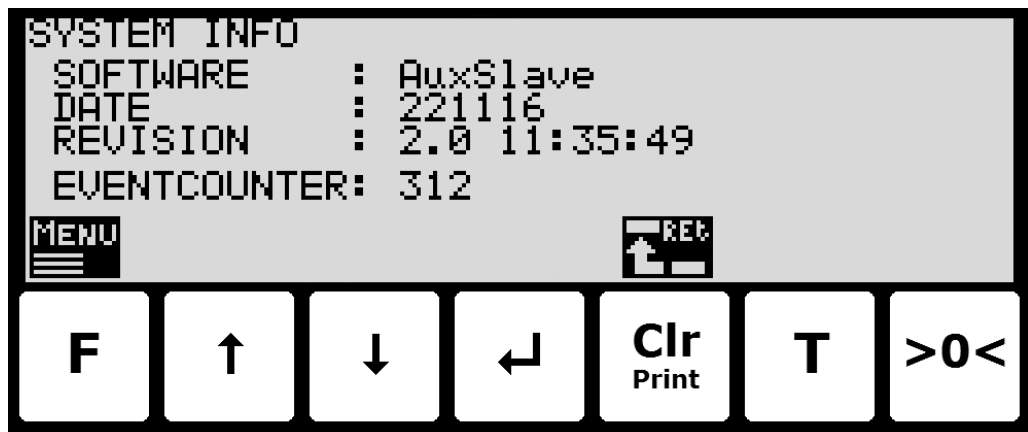

The **SETUP** screen also shows the software version (software name, date and revision):

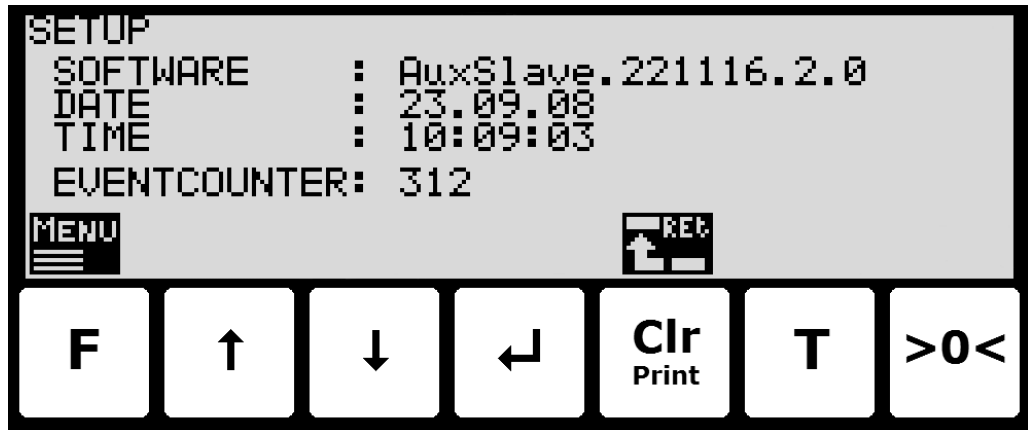

Appendices

Appendix A – 5024G Main Display: Screens overview

The 5024G main terminal has the following screens, which are selected using the menu system. With the Remote Display option enabled an **REMOTE DISPLAY** screen and a **DATA** screen is added:

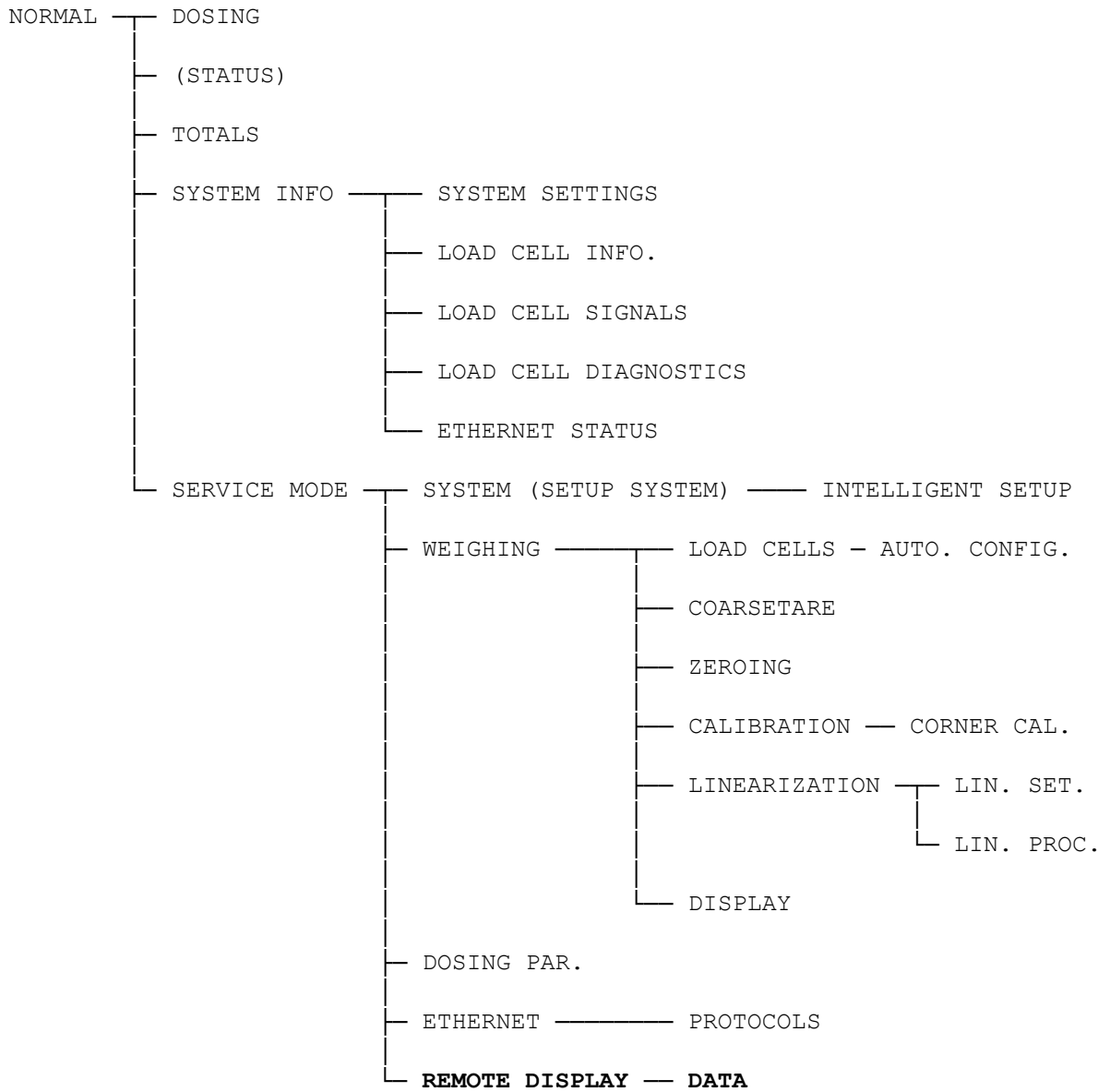

Appendix B – 5024G Remote Display: Screens overview

The 5024G remote display has the following screens, which are selected using the menu system.

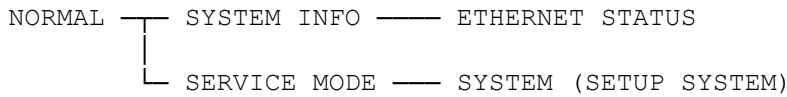

Appendix C – 5024G Main Display: Electrical connection

The following describes the electrical connection of the 5024G main terminal to the 5024G remote display using a RS485 connection.

5024G Main Display: RS485 communication connector

The 3 pin RS485 serial communication connector (J4) on the 5024G main terminal can be used for RS485 communication with external equipment. This connector has the following connections:

J4 pin	Function	Connection
1	RS485-B (negative line)	RS485-B on communication connector J4-1 on the 5024G remote display.
2	RS485-A (positive line)	RS485-A on communication connector J4-2 on the 5024G remote display.
3	RS485-GND	RS485-GND on communication connector J4-3 on the 5024G remote display.



Please notice: A and B line definition may be switched on external equipment. Especially on Siemens equipment and a few other German manufacturers A and B lines definitions are different.



IMPORTANT: Remember to supply power to any external communication devices used. This can be done by connecting +24V and GND (possibly taken from the J1 or J6 connector on the 5024G main terminal) to the used MCE9601 connection module or directly to any power connector on the external device.

Appendix D – 5024G Remote Display: Electrical connection

If a 5024G remote display is connected to the 5024G main terminal (with the software version indicated on the front page), then the 5024G remote display must have the following software version:

5024G.AuxSlave.221116.2v0

(or newer)

5024G Remote Display: Rear view

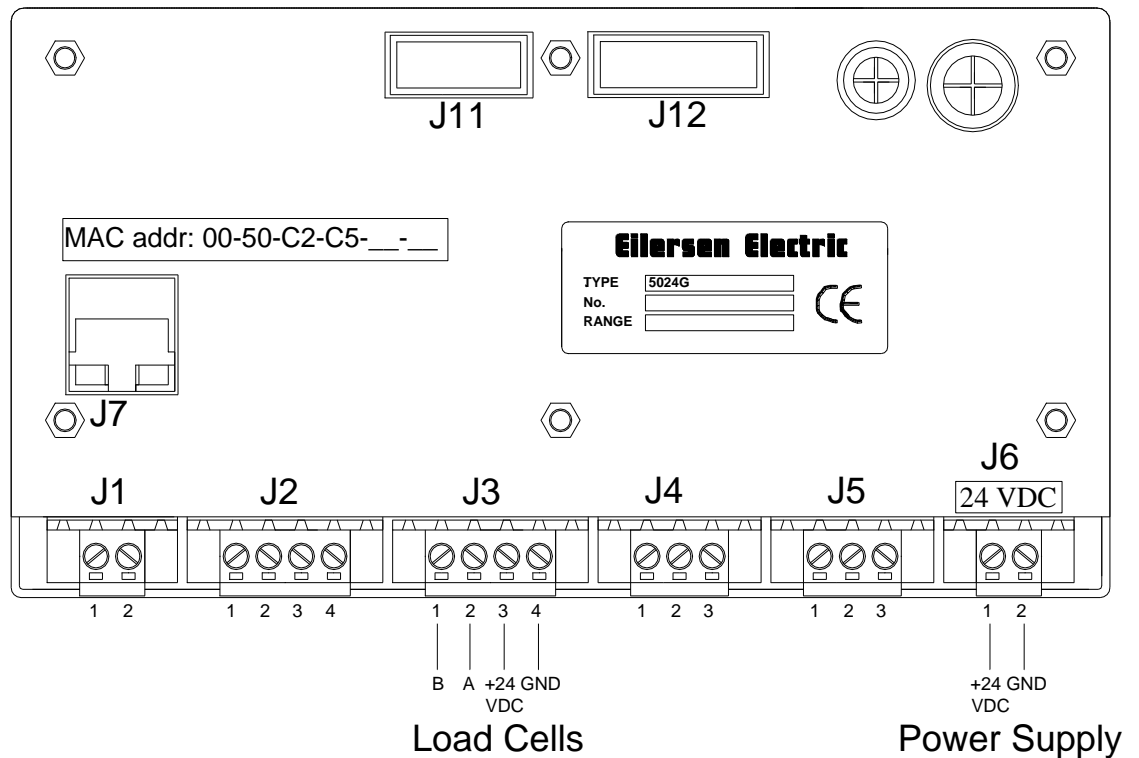

NOTE: On the 5024G remote display ONLY the power connector (J1 or J6) and the RS485 connector (J4) is used; thus no connection of load cells, digital I/O signals or analog output.

5024G Remote Display: Power Connection

The 5024G remote display is powered by +24VDC which is connected to either J1 or J6 (J1 and J6 are internally short-circuited).

J1 pin	Function
1	+24V
2	GND

J6 pin	Function
1	+24V
2	GND

5024G Remote Display: RS485 communication

The 3 pin RS485 serial communication connector (J4) on the 5024G remote display can be used for RS485 communication with the 5024G main terminal. This connector has the following pin-out:

J4 pin	Function	Connection
1	RS485-B (negative line)	RS485-B on communication connector J4-1 on the 5024G main terminal.
2	RS485-A (positive line)	RS485-A on communication connector J4-2 on the 5024G main terminal.
3	RS485-GND	RS485-GND on communication connector J4-3 on the 5024G main terminal.



Please notice: A and B line definition may be switched on external equipment. Especially on Siemens equipment and a few other German manufacturers A and B lines definitions are different.

Revision History

Date	Author	Rev.	Update
2022-11-28	HJA	6v3	<i>Initial document created and adapted. (based on StdLim-201216-1v0-OG-RemDisp-eng)</i>
2023-02-23	HJA	6v4	<i>Updated references to software ID.</i>
2023-03-08	HJA	6v4a	<i>Updated references to software ID for AuxSlave.</i>
2023-05-30	HJA	6v5	<i>Updated references to software ID.</i>
2023-08-09	HJA	6v5a	<i>Updated references to software ID for AuxSlave.</i>
2023-08-29	HJA	6v6	<i>Updated references to software ID.</i>
2023-09-08	HJA	6v6a	<i>Updated with changes due to new software (AuxSlave.221116.2v0). Added so amount of data bytes exchanged between main and re- mote display can and must be set (on both displays).</i>
2024-09-02	HJA	6v7	<i>Added LINEARIZATION SETTINGS screen. Added LINEARIZATION PROCEDURE screen.</i>

Contact

With further questions or improvement suggestions please contact us:

Eilersen

The Weighing Experts

Eilersen Electric A/S
Kokkedal Industripark 4
DK-2980 Kokkedal
Denmark
www.eilersen.com
info@eilersen.com
Tel: +45 49 180 100
Fax: +45 49 180 200

Eilersen
The Weighing Experts